

FOOD HARDWARE **Bakery Service**

Family Owned and Operated Since 1985

Manufacturers, Distributors & Agents for the Bakery & Catering Industry

Home | [Products](#) | [About Us](#) | [Contact Us](#)
[Browse/Download Product Catalogue as PDF](#)





Family Owned and Operated Since 1985

Manufacturers, Distributors & Agents for the Bakery & Catering Industry

[Home](#) | [Products](#) | [About Us](#) | [Contact Us](#)

[Browse/Download Product Catalogue as PDF](#)

VISIT OUR EXTENSIVE SHOWROOM AND SHOP

49 Railway Street
Yennora 2161

Email: sales@foodhardware.com.au

PHONE FOR PERSONALISED SERVICE—02 9681 6544

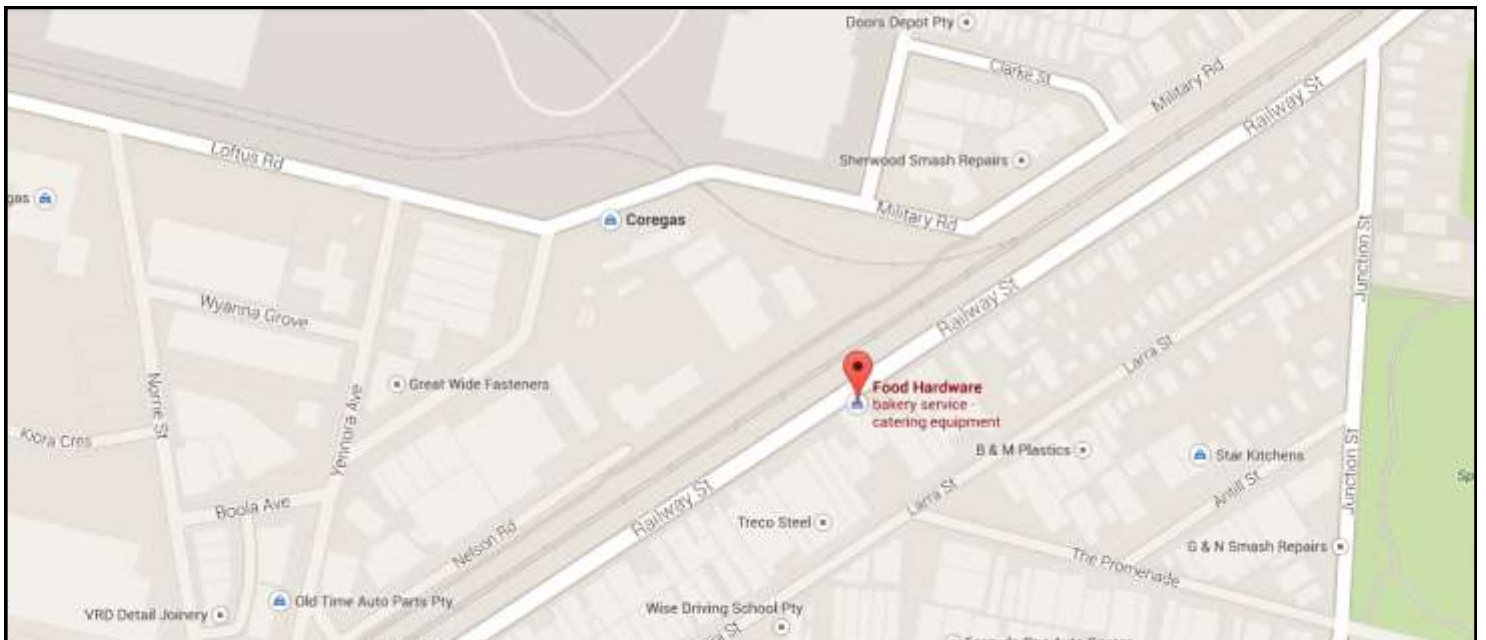

[TRADING HOURS, TERMS AND CONDITIONS](#)



Family Owned and Operated Since 1985

Manufacturers, Distributors & Agents for the Bakery & Catering Industry

[Home](#) | [Products](#) | [About Us](#) | [Contact Us](#)
[Browse/Download Product Catalogue as PDF](#)

TRADING HOURS, TERMS AND CONDITIONS

Trading Hours:	Mon-Fri	8:0am-5:00pm
Payment Options:	C.O.D, C.O.D. Post or Pre Payment with Cheque, Credit Card or EFT (Bank Details Below)	
Bank Details: (EFT Payments)	Bank	- St. George Bank
	Account Name	- Food Hardware
	Account No.	- 204338628
	BSB	- 112-879
Delivery:	We deliver within the Sydney Metro area. Cost of delivery depends on size of order. For deliveries outside Sydney, freight is quoted before despatch of goods or sent by the transport company of your choice	
Prices:	Due to circumstances beyond our control, prices may change without notice and we cannot guarantee all products will be in stock. Imported goods may not be the same as advertised but we will endeavour to stock a similar product. Any prices listed or quoted DO NOT include GST	
Returns: (Stock items only)	Returns must be arranged within 7 days of delivery and must be in unused condition. If return is not made within agreed time, a 20% restocking fee will apply. Returns may be refused and is left to the discretion of FOOD HARDWARE-BAKERY SERVICE	



Family Owned and Operated Since 1985

Manufacturers, Distributors & Agents for the Bakery & Catering Industry

[Home](#) | [Products](#) | [About Us](#) | [Contact Us](#)
[Browse/Download Product Catalogue as PDF](#)

Bakery Service started operations in 1985 repairing, manufacturing and servicing bakery equipment.

During the years our product range has expanded, far beyond that used in the Bakery industry.

It was decided a second trading name **FOOD HARDWARE** should be introduced to the sales and marketing of all our products related to the food industry.

We sell racks, benches, pots, pans, stirrers, timers, thermometers, scrapers, bowls, crockery, etc... any item used to prepare food we supply it to you the professional in the food preparation industry.

We are constantly improving our range and if you don't see it on this website, please contact our showroom and we will endeavour to help you with your request.

We have a large range of equipment and utensils on display at our Showroom at 49 Railway Street, Yennora where you can buy on a walk in basis.

[TRADING HOURS, TERMS AND CONDITIONS](#)

MAIN INDEX

[Home](#) | [Products](#) | [About Us](#) | [Contact Us](#)

[Click here for a detailed index](#)

0000 - 0999



[Large Equipment](#)

1000 - 1999



[Bench Top Equipment](#)

2000 - 2999

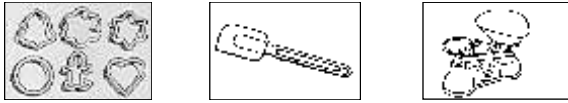

[Utensils-Decorating](#)

3000 - 3999



[Small Machines](#)

4000 - 4999

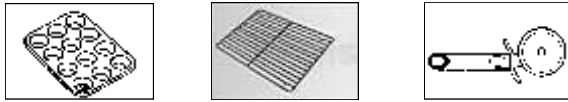

[Bakeware](#)

5000 - 5999



[Table-Top & Serving](#)

[Signage & Menu](#)

6000 - 6999



[Housekeeping](#)

7000 - 7999



8000 - 8999



[Furniture & Shelving](#)

9000 - 9999



[Miscellaneous](#)

[Click here for a detailed index](#)



FOOD HARDWARE Bakery Service

Family Owned and Operated Since 1985

Manufacturers, Distributors & Agents for the Bakery & Catering Industry

[Home](#) | [Products](#) | [About Us](#) | [Contact Us](#)

[Browse/Download Product Catalogue as PDF](#)

[Baking Sheets & Trays \(4101\)](#)

[Baking Tins \(4301\)](#)

[Benches/Accessories \(0201\)](#)

[Benchtop Products \(1301\)](#)

[Bread Pans & Accessories \(4201\)](#)

[Bread Slicers \(0801\)](#)

[Cash Registers \(9103\)](#)

[Cleaning Hardware \(7201\)](#)

[Clearing Trolleys \(5601\)](#)

[Cold Storage \(0301\)](#)

[Cooking Pots & Pans \(1101\)](#)

[Crockery \(5100\)](#)

[Cutlery \(5500\)](#)

[Decorating Utensils & Equipment \(2400\)](#)

[Deep Fryer Baskets/Lifters/Skimmers \(1311\)](#)

[Equipment-Freestanding \(0800\)](#)

[Foodbar Accessories \(0407\)](#)

[Food Processors \(3101\)](#)

[Furniture \(8103\)](#)

[Gas Equipment \(1400\)](#)

[Housekeeping/Miscellaneous \(7401\)](#)

[Ice Slicers - \(3301\)](#)

[Juicers \(3401\)](#)

[Kitchen Utensils \(2101\)](#)

[Knives & Sharpeners \(2700\)](#)

[Measuring \(2600\)](#)

[Miscellaneous \(9101\)](#)

[Mixers - Drink \(3101\)](#)

[Mixers - Planetary/Spiral \(0801-0804\)](#)

[Ovens & Hot Storage \(0401\)](#)

[Pasta Aids \(3205\)](#)

[Pastry Sheeter/Moulder \(0800\)](#)

[Pastry Utensils \(2200\)](#)

[Pizza Dough Roller \(0801\)](#)

[Pizza Ware \(4501\)](#)

[Protective Wear \(7101\)](#)

[Racks/Trolleys/Baskets \(0101\)](#)

[Refrigeration/Freezing \(0901\)](#)

[Serving & Display \(2301\)](#)

[Shelving \(8101\)](#)

[Signage \(6103\)](#)

[Silicone Bakeware \(4105\)](#)

[Spray Guns \(KREA Swiss\) \(3501\)](#)

[Stainless Steel Cups & Mugs \(5201\)](#)

[Stainless Steel Jugs \(5401\)](#)

[Storage Containers/Trolleys \(0501\)](#)

[Tickets & Price Tags \(6101\)](#)

[Utensils \(2801\)](#)

[Wheels/Accessories \(0700\)](#)

RACKS, TROLLEYS, BASKETS

BAKERY SERVICE MANUFACTURED TRAY RACKS		
Description	Dimensions	Code
Zinc Plated Racks for Tray size 16 x 29" (405 x 735mm)	20 tray/End loading 20 tray/Side loading 15 tray/End loading 15 tray/Sideloadng 12 tray/End loading 10 tray/End loading 10 tray/End loading 8.0tray/End loading	R12042MZ R22074MZ R11542MZ R21574MZ R31242MZ R11042HX R11042HZ R10842MZ
S/S Racks for Tray size 16 x 29" (405 x 735mm)	20 tray/End loading 20 tray/Side loading 15 tray/End loading 15 tray/Side loading 12 tray/End loading	R12042MX R22074MX R11542MX R21574MX R31242MX
Zinc Plated Racks for Tray size 18 x 29" (460 x 735mm)	20 tray/End loading 20 tray/Side loading 15 tray/End loading 15 tray/Side loading	R12047MX R22074MX R11547MZ R21574MZ
Back Stop, Zinc plated, Available for all racks sizes	400mm long x 280 wide	R Stop
S/S Racks for Tray size 18 x 29" (460 x 735mm)	20 tray/End loading 20 tray/Side loading 15 tray/End loading 15 tray/Side loading	R12047MX R22074MX R11547MX R21574MX
Racks to take 18" trays cost the same as 16" in most cases		
A removable backstop can be fitted to your rack on request		

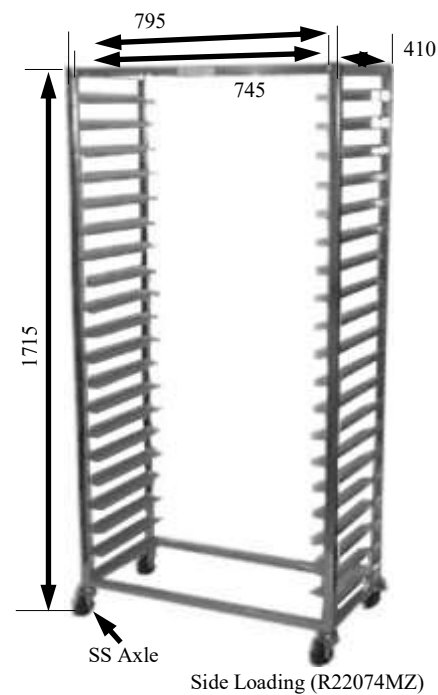
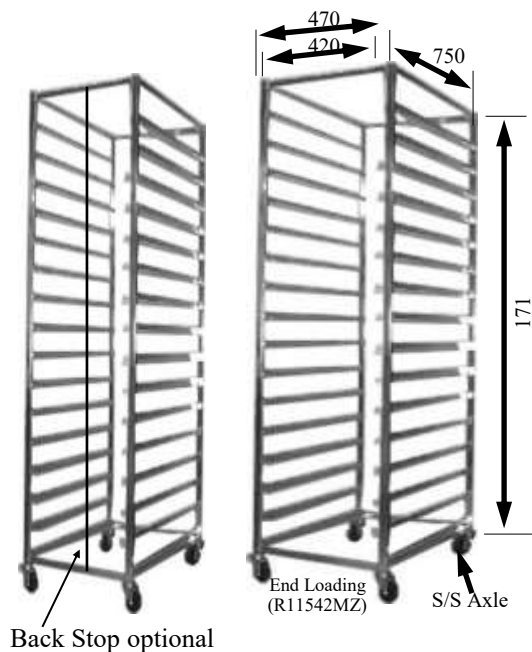

RACKS, TROLLEYS, BASKETS

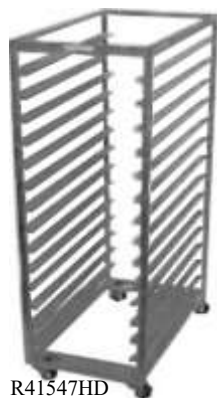

LCOVERS



3JCOVER



3JDISPC



RC08SLMPC



K0287E17T



K0287N



K0287HALFD

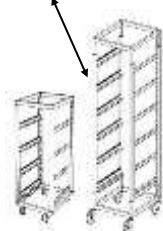

COOLER RACK

Description	Dimensions	Code
Rack for large cooler 15 tray capacity with 10cm spacing Zinc plated	Internal: 90 x 46cm Overall size: 52 x 92 x 161 cm	R41547ZP

RACK COVERS—Plastic/Material/Disposable

Description	Dimensions	Code
HD Material, 4 Zippers	Fits End Loading Rack 16 & 18"	3JCOVER
Disposable Rack Covers 100 pk	Fits End Loading Rack 16 & 18"	3JDISPC

Rack covers also made to order

BREAD CRATE RACKS

Description	Dimensions	Code
8 Bread Crate Rack -Powder coated -Slanted runners -Holds 8 plastic 11CRATES	1720 H x 750 W x 585 D	RC08SLMPC
10 Bread Crate Rack -Powder coated -Straight runners -Holds 10 plastic 11CRATES	1710 H x 750 W x 625 D	RC10STMPC

GASTONORM TROLLEY

Description	Dimensions	Code
17 Tray 1/1 325x530 with tray locks & locking castors	200mm long x 135 wide	K0287E17TL
18 Tray 2/1 530x650 with tray locks & locking castors	260mm long x 185 wide	K0287N
9 Tray Half Height Gastronorm Trolley Single	325mm long x 235 wide	K0287HALFS
18 Tray Half Height Gastronorm Trolley Double	400mm long x 280 wide	K0287HALFD
12 Tray 530x650mm (112mm centres)	480mm long x 330 wide	K028712

GLASS BASKET TROLLEY/RACK

Description	Dimensions	Code
4 Basket Trolley (single unit) Comes fitted with 50mm ball castors, 4 runners adjustable every 25mm, and a base drip tray runner. Available in 6, 8, 10, 12 & 16 basket	Overall: 425 x 490 x 830mm.	1E8-044

Top and base frames are stainless steel, uprights and runners are made of anodised aluminium
Trolleys may have a 35mm deep 'drop-in' stainless steel top tray

RACKS, TROLLEYS, BASKETS

STORAGE/PROOVER CABINET

Description	Dimensions	Code
Locking Handle, S/S hinges Door rubber fitted, Zinc plated frame Colorbond paneling, Removable floor	H: 1720 x W: 470 x D: 775	RCAK42CBZP
Available in Full Stainless Steel		RCAK4SS



Wood Display Rack
3QWOODRACK

BASKET DISPLAY RACKS

Description	Dimensions	Code
Wooden Display Rack Takes cooling wires and baskets (deep & shallow) Suits 18 x 36" cooling wire/basket	985 x 500 x 1800mm	3QWOODRACK
Straight Basket Rack Holds 9 baskets. Straight only Takes cooling wires and baskets (deep & shallow) Suits 18 x 36" cooling wire/basket	980 x 490 x 1720mm	R40992STZ
Slanted/Straight Basket Rack Holds 5 baskets. Slanted or straight Takes cooling wires and baskets (deep & shallow) Suits 18 x 29" cooling wire/basket	980 x 490 x 1720mm	R40592SLZ
Slanted Basket Rack Holds 5 baskets. Slanted only Takes cooling wires and baskets (deep & shallow) Suits 18 x 29" cooling wire/basket	800 x 470 x 1720mm	R40574SLZ



R40992STZ

COOLING WIRE BASKETS

Description	Dimensions (mm)			Code
	Length	Width	Depth	
Deep	915	457	150	CT4BA15CP
Shallow	915	457	50	CT4BA5CP
Deep	735	457	150	CT3BA15CP
Shallow	735	457	50	CT3BA5CP
Wires - heavy duty	915	457		CT4CWHDCP
With P/Stop	915	457		CT4CWHDCPPS



R40574SLZ



CT4CWHDC



R40592SL

RACKS, TROLLEYS, BASKETS



2 Drawer Bin Rack



3 Drawer Bin Rack



6 Drawer Bin Rack



7 Drawer Bin Rack



3 x 3 Drawer Bin Rack

BIN RACKS

Description	Dimensions (mm)			Code
	Height	Width	Depth	
2 Drawer Bin Rack Zinc Plated Stainless Steel	730	470	645	R50242Z R50242S
3 Drawer Bin Rack (Holds Nally No. 7 Bin [JAP7]; or 2 x No. 7 [JAP7] & 1 x No. 10 [JAP10] on bottom) Zinc Plated Stainless Steel	800	470	645	R50342Z R50342X
6 Drawer Bin Rack (Holds Nally No. 10 Bin [JAP10]) Zinc Plated Stainless Steel	1830	470	645	R50642Z R50642X
7 Drawer Bin Rack (Holds Nally No. 7 Bin [SIH060-W]) Zinc Plated Stainless Steel	1700	470	645	R50742Z R50742X
3 x 3 Drawer Bin Rack (Holds 3 x Nally No. 7 Bins [JAP] & 3 x Nally No. 10 Bins [JAP10]. See under "Bin – Ingredient") Zinc Plated Stainless Steel	1660	470	645mm	R53342Z R53342X
Optional extras: Zinc Plated top S/S top				R5T42X R5T42ZP
All of our Bin Racks have the following as standard features: Back stop built in. Tight as possible fitting lids. Protector strip fitted to prevent injury. Stainless steel axle in wheels to prevent locking up (see under "Bin– Ingredient")				

NB. Zinc Plated is suitable for **Dry and Non abrasive** ingredients.
Stainless Steel is suitable for **Wet areas and all types of ingredients**

BENCHES / ACCESSORIES

STAINLESS STEEL TOP WORK BENCHES			
Description	Dimensions (mm)		Code
	Width	Height	
S/S 2mm Top, Galvanised shelf on castors	1100	2900	B1129
	1100	2300	B1123
	1100	1700	B1117
	1100	1400	B1114
	1100	1100	B1111
	800	2900	B0829
	800	2300	B0823
	800	1700	B0817
	800	1400	B0814
	800	1100	B0811



Slicer Stand Frame with crumb bin on adjustable feet (Shown with Bread Slicing Machine)



Slicer stand with Drop on Stainless Steel or Galvanised Shelves to be used as Work Bench

SLICER STANDS			
Description	Dimensions		Code
	Width	Height	
Slicer stand Zinc plated on lockable wheels	540	570	RLSTANDW
Slicer stand Zinc plated on adjustable feet	540	570	RLSTANDF
Drop on Shelf (Stainless Steel)			RLSTANDSX
Drop on Shelf (Galvanised)			RLSTANDSZ

Choose your configuration

- Centre Bench or Wall bench
- Feet or wheels (Brake wheels available)
- Open or Closed Frame
- Extra Shelves (Stainless or Galvanised)
- Tray Runners fitted (How many sets) - Supply your tray size
- Bin Racks (Fitted or under Bench)



Appliance Bench
Ideal for Mixer or Cooker Bench only
Top 500x800mm
Optional Utensil Drawer

SINK BENCH		
Description	Dimensions	Code
Made to order Sinks heavy duty S/S - Variety of sizes available - Sturdy bottom shelf to meet height requirements		



Centre Bench
Open Frame on Wheels with
Adjustable shelf & Utensil drawer



Centre Bench
Open Frame, Adjust. Feet



Centre Bench on wheels
With extra S/S shelf



2ZRS7180-2C

BENCHES / ACCESSORIES



1700 x 800mm
Stainless Steel Centre Bench
on wheels with tray runners



2900 x 800mm
Stainless Steel Centre Bench



800 x 1400mm
Centre Bench, open frame on feet



1100 x 1100mm
Stainless Steel Centre Bench



800 x 1700mm
Wall bench with shelf on wheels with
dough box runners fitted



Draw Rack to fit in
bench. Plated finish
holds 3 bins.

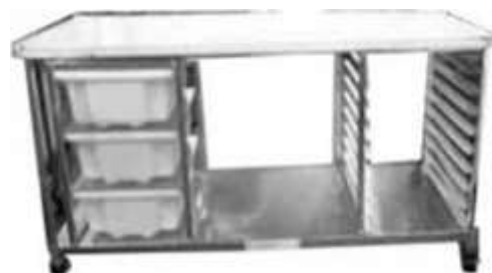

Centre Bench on wheels with 1 set of tray
Runners and 3 drawer ingredient rack



1100 x 500mm
Stainless Steel Centre Bench Top
galvanised shelf on wheels



800 x 1400mm
Center Top Shelf on adjustable feet

**If what you want is not
shown on these pages,
consult for other
combinations.**



Stainless steel Drawer
Shroud 435x430x210mm



Stainless steel Gastronorm Drawer
Can be fitted to all benches
Suit full size pan up to 150 mm deep

COLD STORAGE

REFRIGERATED FOOD DISPLAY BARS

Description	Dimensions (mm)			Code
	Height	Width	Depth	
Single Row - Straight glass	675	1135	408	2ZER14RD
	675	1400	408	2ZER15RD
	675	1665	408	2ZER16RD
Double Row - Straight glass	675	705	615	2ZER22RD
	675	1030	615	2ZER23RD
	675	1355	615	2ZER24RD
	675	1680	615	2ZER25RD
	675	2005	615	2ZER26RD
Double Row - Curved glass front	750	705	615	2ZCR22RD
	750	1030	615	2ZCR23RD
	750	1355	615	2ZCR24RD
	750	1680	615	2ZCR25RD
	750	2005	615	2ZCR26RD

* Above models all operate with a single refrigeration coil. Cross fin coil option is available and recommended at all times.
 * Rear glass doors standard.
 * Pans not included in above models.
 * Local health regulations can vary, please ensure intended use of these machines complies before ordering.

For more information on steam pans available, please see STEAM PANS on pages 0407-0408



2ZER24



2ZCR24



2ZET24



2ZET24 + ETP



2ZECT23

FOOD BAR & BAIN MARIE OPTIONS & ACCESSORIES

Description	Code
TROLLEYS All designed to suit double row units these trolleys are solidly constructed, easy to assemble and include four castors for mobility. Two castors include brakes to ensure safe and sturdy functionality. All units include under shelf. Supplied flat-packed for self-assembly	2ZE??
S/S Front & Side Panels available for trolleys	2ZETP??
CHICKEN TRAY Designed to drop into all double row food bars. Constructed in S/S with removable perforated inserts. Prevents chickens from sitting in oil whilst on display.	2ZECT23
TRAY RACES To suit Food Bars. Manufactured from S/S, 207mm deep. Supplied loose to be affixed on site	2ZTR??
SNEEZE GUARDS To suit E and ER series only. Fitted Either or Both sides (front side Only On single row) Guards are 180mm high	2ZESG??

COLD STORAGE

2ZBMH2

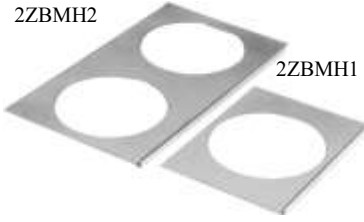

2ZBMH1



2ZBMH3



2ZECB2

2ZECB1

FOOD BAR & BAIN MARIE OPTIONS & ACCESSORIES - cont..

Description

Code

Hobs

To take one round steam table insert (7.25 litres). Fits 100, 105 & 200 series Bain Maries

2ZBMH1

To take two round steam table inserts (7.25 litres). Fits 105 & 200 series Bain Maries

2ZMBH2

To take one round steam table insert (7.25 litres). Fits double row food bars only at rear and BM series Bain Maries

2ZBMH3

Cross Bars

To support smaller size combination of steam table pans.

2ZECB1

2ZECB2

BAIN MARIES - Refrigerated

Description

Dimensions (mm)

Code

Max. pan depth 65mm

Height

Width

Depth

4 x ½ size

225

700

615

2ZBR22

6 x ½ size

225

1030

615

2ZBR23

8 x ½ size

225

1355

615

2ZBR24

10 x ½ size

225

1680

615

2ZBR25

12 x ½ size

225

2005

615

2ZBR26

Designed to hold food at serving temperatures.

Quality refrigeration unit running on R22 refrigerant

Refrigerated condensing units can be supplied separately for remote installation

12.7mm drain



2ZBR25

OVENS & HOT STORAGE

HOT DISPLAY COUNTERS

Description	Capacity	Dimensions		Code
		Width (mm)		
Single Row, Straight Glass Front (½ size 65mm pan)	(4-pan)	1135		2ZE14RD
	(5-pan)	1400		2ZE15RD
	(6-pan)	1665		2ZE16RD
Double Row, Straight Glass Front (½ size 65mm pans)	(4-pan)	705		2ZE22RD
	(6-pan)	1030		2ZE23RD
	(8-pan)	1355		2ZE24RD
	(10-pan)	1680		2ZE25RD
	(12-pan)	2005		2ZE26RD
Double Row, Curved Glass Front ½ size 65mm pans	(4-pan)	700		2ZC22RD
	(6-pan)	1030		2ZC23RD
	(8-pan)	1355		2ZC24RD
	(10-pan)	1680		2ZC25RD
	(12-pan)	2005		2ZC26RD

- * Pans not included in above models.
- * Also available with rear glass doors
- * Local health regulations can vary, please ensure intended use of these machines complies before ordering.

For information on steam pans available, please see under STEAM PANS on page 0407-0408



2ZE14-65



2ZE23-65



2ZC23



2ZBM25A

BAIN MARIES - Hot

Description	Dimensions (mm)			Code
	Height	Width	Depth	
Max. pan depth 100mm				
4 x ½ size x 100mm pans & lids	255	1135	408	2ZBM14A
5 x ½ size x 100mm pans & lids	255	1400	408	2ZBM15A
6 x ½ size x 100mm pans & lids	255	1665	408	2ZBM16A
4 x ½ size x 100mm pans & lids	255	700	615	2ZBM22A
6 x ½ size x 100mm pans & lids	255	1030	615	2ZBM23A
8 x ½ size x 100mm pans & lids	255	1355	615	2ZBM24A
10 x ½ size x 100mm pans & lids	255	1680	615	2ZBM25A
12 x ½ size x 100mm pans & lids	255	2005	615	2ZBM26A

- Designed to hold food at serving temperatures.
- S/S construction
- Removable cross bars
- 12.7mm drain
- Wet or dry operation
- Incoloy metal elements with energy regulator control
- Designed to take many combinations of gastronorm pans

OVENS & HOT STORAGE



2ZPA50



2ZPA100



2ZPM60G



1MPW-RT/660/TG

PIE WARMERS

Description	Dimensions (mm)			Code
	Height	Width	Depth	
50 pies, S/S body, 1250 watts	485	585	350	2ZPA50 2ZPA50G*
100 pies, S/S body, 1550 watts.	563	748	350	2ZPA100 2ZPA100G
50 pies, S/S body, 1250 watts with light	485	585	350	2ZPW50 2ZPSW0G
100 pies, S/S body, 1550 watts with light	563	748	350	2ZPW100 2ZPS100G

* G - Denotes glass doors both sides.

SLANTED FRONT PIE WARMER

Description	Dimensions (mm)			Code
	Height	Width	Depth	
60 pie capacity, 4 Shelves, 2000 watts, 240v Stylish design, Black powder coated body 10 Amp unit	669	652	488	2ZPM60
60 pie capacity, 4 Shelves, 2000 watts, 240v Sliding glass doors front & rear, 10 Amp unit	669	652	488	2ZPM60G

- Highly efficient fan-forced thermal air-flow & humidity
- Suitable for all hot foods
- Thermostat control to 110°C with temp. read-out
- Over-temp cut-out @ 130°C
- Black, gold or orange/red
- Front & rear sliding doors

PIE WARMERS & FOOD DISPLAY

Description	Dimensions	Code
3 Adjustable shelves Heated Humidity water reservoir Toughened front & rear Sliding doors	Width (mm) 660	1MPW-RT/660/TG
3 Adjustable shelves Heated Humidity water reservoir Toughened front & rear Sliding doors	900	1MPW-RT/900/1
3 Adjustable shelves Heated Humidity water reservoir Toughened front & rear Sliding doors	1200	1MPW-RT/1200/1

OVENS & HOT STORAGE



2Z40DT

PIE WARMERS				
Description	Dimensions (mm)			Code
	Height	Width	Depth	
40 pies, S/S front, 1250 watts	360	505	320	2Z40DT
80 pies, S/S front, 1250 watts	485	585	350	2Z80DT
Sliding doors, 3 remov. shelves, 1250 watts	485	585	350	2Z83DT



2Z80DT



2Z83DT

OVENS & HOT STORAGE

KAM PIE WARMERS				
Description	Dimensions (mm)			Code
	Height	Width	Depth	
KAM 8 Hot Holding Cabinet - 8 trays * Capacity 240 Pies * Single phase 240 volt with internal lighting	825	895	575	3KKAM8-3



KAM Front Counter



KAM Full Tray Loading Front & Back



SEE NEXT PAGE FOR CONFIGURATION FEATURES

OVENS & HOT STORAGE

SOME CONFIGURATIONS & FEATURES

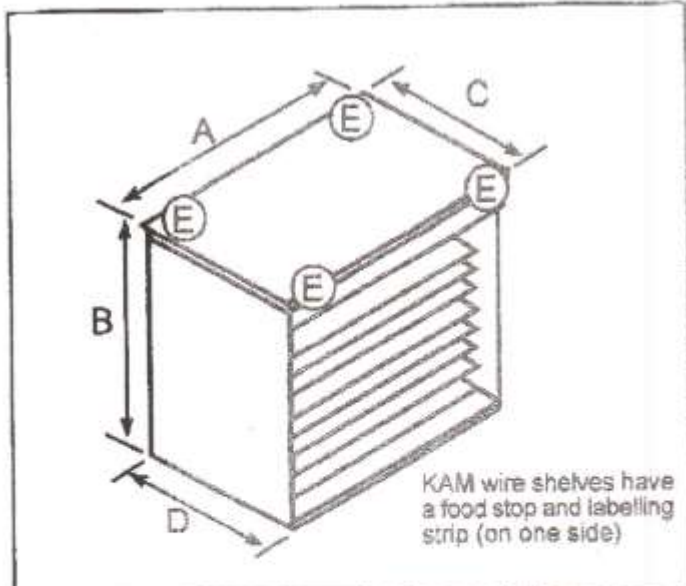

- Finish:** All stainless steel
Model: KAM 8-3 (Hot holding cabinet)
- ★ 4 tube lights give brilliant display ***
 - ★ Features 1°C Pinpoint Variation Electronic Temperature Sensing
 - ★ Fully insulated sides, top & base
 - ★ Gentle Giant blanket-type spread heating
 - ★ Can heat to 110°C if desired
 - ★ Can be computer compatible for HACCP records
 - ★ Can be up to 8 wire shelves or down to your choice
Wire size 29" x 18" max. (737x457mm)
 - ★ Lift-out shelf runner assemblies
- Dimensions:** A: 885mm C: 625mm
 B: 850mm D: 570mm
 E= Electricity lead outlet options at top (15 amp)

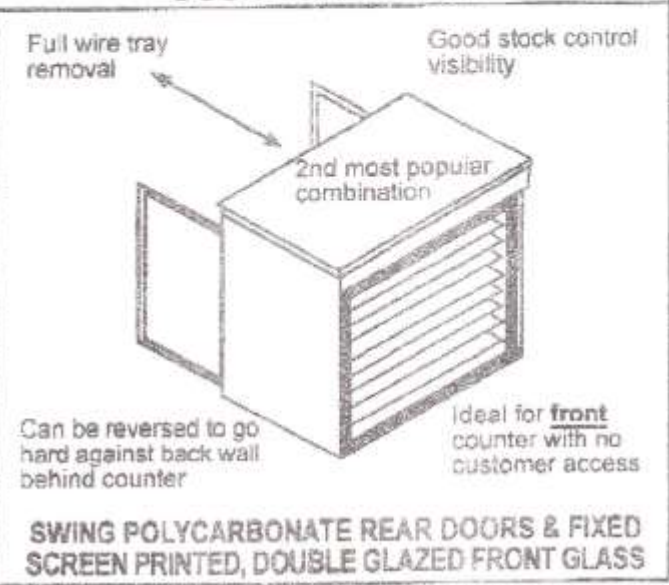
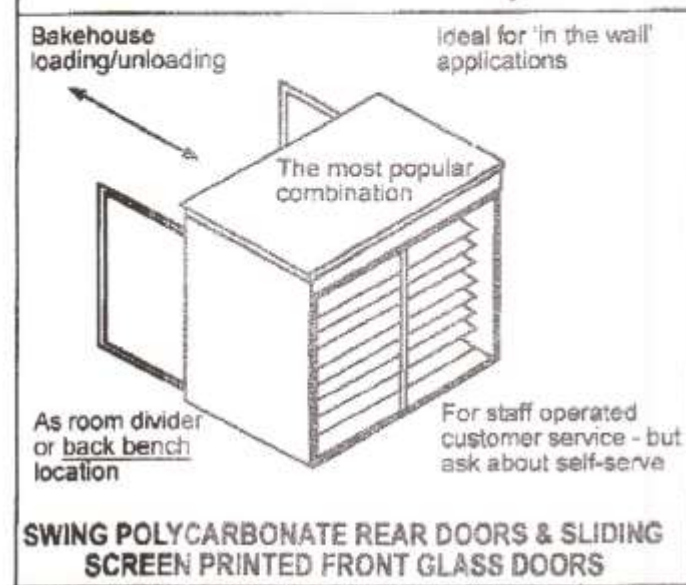
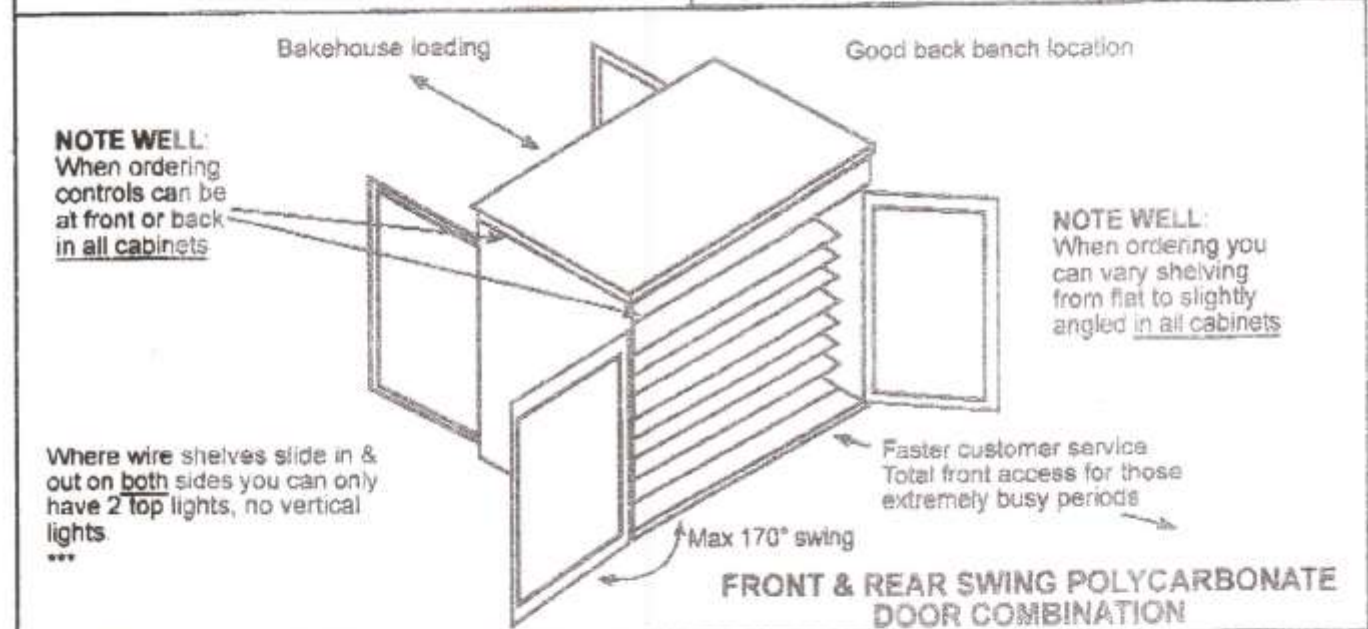

(Details subject to alteration without notice) **KAM** Since 1981 (illustrations do not cover full range of options)

OVENS & HOT STORAGE



VMLD510SEA



VMLD510



2VE27



2VG32



E2V35-26



1MEP-1-1



OVENS				
Description	Dimensions (mm)			Code
	Width	Height	Depth	
Commercial Microwave Dial Operation Programmable Menu - 5 Power level option, 7 amp, single phase, 22 kg Features: 250V-10a • 34L Capacity, Energy Rating of 1000W • Stainless Steel	560	344	483	VMLD510SEA
	560	344	483	VMLD510
BAKBAR (TURBOFAN Range) Turbofan E 27 Electronic Convection oven, provides a fast, even bake. Baffle system & reversing fan, hot air around the oven. Par-baked & pre-proofed frozen doughs. Ideal for baking croissants, Danish pastries, flat bread, frozen pizza 3 Tray Capacity (2 wire racks supplied) Bi-directional reversing fan system 60 minute bake timer, S/S exterior Internal lighting, Drop down door Stands optional				2VE27
Turbofan E 32 The Most versatile electric convection oven. Able to handle four 460x660mm full size baking trays. Ideal for baking, roasting, holding & dedicated product functions. Low velocity fans, Low gas usage requirements, easy to install & easy to clean. Only E 32 available in Gas Stands optional				2VG32
Turbofan E 35 The largest model from Bakbar, accurate baking, greater capacity & flexibility, Dual direction fan, regeneration & roasting oven. Stand optional. Two sizes available.	880		880	2VE35-26
	880		980	2VE35-30
Deck Ovens (Willet, Craftsman, Rote) Fits three trays if end-loaded or four trays if side-loaded x two deep • accurate thermal regulators for top & bottom elements • each deck is complete with timer for individual deck by deck control • large tray size – 456 or 406 mm x 740 (18" or 16" x 29") • 415VAC; 3~N 10kW, Available in 1 to 5 decks STEAM OPTION available STONE BASE available for PIZZA	External size per deck 2100 520 1170 Internal size per deck 1550 180 1000 Overall oven heights including legs & castors: One deck - 1350, Two deck - 1690, Three deck - 1870, Four deck - 2200			
Pizza Deck Oven * Black Panther * Fast, Hot (500°C) & Compact; Superior insulation * Top & bottom controls for perfect cooking * Temperature range 50c to 500c Available in 3 different sizes Single & double Deck				1MEP-1-1

FOOD BAR ACCESSORIES

STEAM PANS S/S				
Description	Dimensions (mm)			Code
	Length	Width	Depth	
Full Size	527	325	25	2ZZ11025
			65	2ZZ11065
			100	2ZZ11100
			150	2ZZ11150
2/3 Size	352	325	65	2ZZ23065
			100	2ZZ23100
			150	2ZZ23150
1/2 Size	265	325	65	2ZZ12065
			100	2ZZ12100
			150	2ZZ12150
			200	2ZZ12200
1/3 Size	176	325	65	2ZZ13065
			100	2ZZ13100
			150	2ZZ13150
1/4 Size	162	265	65	2ZZ14065
			100	2ZZ14100
			150	2ZZ14150
1/6 Size	162	176	65	2ZZ16065
			100	2ZZ16100
			150	2ZZ16150
1/9 Size	108	176	65	2ZZ19065
			100	2ZZ19100



STEAM PANS S/S - Perforated				
Description	Dimensions (mm)			Code
	Length	Width	Depth	
Full Size	527	325	25	2ZZ11025-P
			65	2ZZ11065-P
			100	2ZZ11100-P
			150	2ZZ11150-P
1/2 Size	265	325	65	2ZZ12065-P
			100	2ZZ12100-P
			150	2ZZ12150-P



FOOD BAR ACCESSORIES



STEAM PANS S/S				
Description	Dimensions (mm)			Code
	Length	Width	Depth	
Full Size				2ZZ11000C
2/3 Size				2ZZ23000C
1/2 Size				2ZZ12000C
1/3 Size				2ZZ13000C
1/4 Size				2ZZ14000C
1/6 Size				2ZZ16000C
1/9 Size				2ZZ19000C



POLYCARBONATE GASTRONORM PANS: Black/Clear				
Description	Dimensions (mm)			Code
	Length	Width	Depth	
Full Size	527	325	65	2ZB11065
			100	2ZZ11065
			150	2ZZ11100
2/3 Size	352	325	65	2ZZ23065
			100	2ZZ23100
			150	2ZZ23150
1/2 Size	265	325	65	2ZZ12065
			100	2ZZ12100
			150	2ZZ12150
			200	2ZZ12200
1/3 Size	176	325	65	2ZZ13065
			100	2ZZ13100
			150	2ZZ13150
1/4 Size	162	265	65	2ZZ14065
			100	2ZZ14100
			150	2ZZ14150
1/6 Size	162	176	65	2ZZ16065
			100	2ZZ16100
			150	2ZZ16150
1/9 Size	108	176	65	2ZZ19065
			100	2ZZ19100



BAIN MARIE POTS			
Description	Capacity (L)	Height (mm)	Code
18/8 Steam Table Insert	4.13	166	2ZZ014
	7.25	216	2ZZ017
	11.0	215	2ZZ020
Cover for: 2ZZ014 2ZZ017 2ZZ020			2ZZ014C 2ZZ017C 2ZZ020C

STORAGE CONTAINERS

CANNISTERS

Description	Capacity (L)	Code
18/8 Cannister	1.0	Q05401
	2.0	Q05402
	3.0	Q05403
	4.0	Q05404
	6.0	Q05406
	8.0	Q05408
	Covers for: Q05401 Q05402 Q05403 Q05404 Q05406 Q05408	



FOOD STORAGE CONTAINERS

Description	Capacity (L)	Code
Cambro Food Container. Clear polycarbonate, graduated Unbreakable, dishwasher safe	2.0	V2SFSCW
	4.0	V4SFSCW
	6.0	V6SFSCW
	8.0	V8SFSCW
Lid (Green) for: 2 & 4 ltr size Lid (Red) for 6 & 8 ltr size		VSFC2 VSFC6
Thermo Hauser with special hermetical seal/lid 170 x 140 x 210mm	1.0	Q31030



V6SFSCW



LIH997

LIH981

LIH995

LUBH/

WALL RACK

Description	Dimensions (mm)			Code
	Height	Width	Depth	
Wall Rack only (Thermo Hauser)	185	900	125	Q31031

CRATES

Description	Dimensions (mm)			Code
	Length	Width	Depth	
Plastic Crates Collapsible	692	436	150	LIH981
Plastic Crates	756	555	142	LIH995
Plastic Grey Basket	710	458	103	LIH997
Plastic Grey Basket	694	605	151	LUBH/N
Plastic Blue Basket	600	690	150	IICRATE
Plastic Dolly single & Double	705	615		RDOL1
	705	1290		RDOL2



RDOL1



RDOL2

STORAGE CONTAINERS

STORAGE CRATES (range of colours available)

Description	Capacity (L)	Dimensions (mm)			Code
		Length	Width	Depth	
Series 2000 - Solid	26.0	578	384	166	SH2260-WH
Series 2000 - solid side, mesh base	26.0	578	384	166	SH2264
Lid for Crate Series 2000					SH2000
Crate - Beige	18.0	585	260	178	SIH003
Lid to suit					SIH978
Stacking Container - solid base	29.0	641	413	171	SIH007-WH
Stacking Tray Model 90	21.0	660	334	121	SIH047-WH
Crate No 3 (white)	11.0	510	200	130	SIH077-WH
Crate No.4 (white)	13.5	430	323	127	SIH089-WH
Crate (white)	20.0	590	260	175	SIH044
Crate No.5 (white)	22.7	527	381	140	SIH059-WH
Crate No.7 (blue)	32.0	645	413	210	SIH060-BL
Crate No.7 (red)	32.0	645	413	210	SIH060-RE
Crate No.7 (natural)	32.0	645	413	210	JAP7
Crate No.10 (natural)	52.0	645	413	276	JAP10
Crate No.12 (natural)	55.0	710	438	382	JAP12
Crate No.15 (natural)	68.0	645	413	397	JAP15
Lid for No.4 Crate		440	332	20	SIH014-WH
Lid for No.5 Crate (white)		546	392	25	SIH015
Lids for Crates 7, 10, 15 (natural)		656	425	32	JAP7/10L
Tub Trolley, suits No. 7, 10, 15 Nally Bins		375	607	45	K1971
Tub Dolly: Suits All Nally Bins		375	610		K1976

SIH2260-WH



SIH014



SIH059



SIH015



SIH047



JAP7



JAP7/10



JAP10



JAP12



SIH089



JAP15



K1971



K1976



STORAGE CONTAINERS & TROLLEYS

INGREDIENT BINS / BUCKETS

Description	Capacity (L)	Dimensions (mm)		Code
		Height	Width	
Mobile Bin - Natural	80	850	445mm	DAP8000NL
	120	880mm	480mm	DAP8002NL
	240	1000mm	580mm	DAP8001NL
Rubbish bin with lid	55 ltr	490mm	450mm	JAPER-55L
	75 ltr	550mm	500mm	JAPER-75L
15 Gallon Bin - white	67.0 ltr	535mm	508mm	SIP015-WH
18 Gallon Bin - white	84.0 ltr	535mm	590mm	SIP018-WH
25 Gallon Bin - white	113 ltr	470mm	640mm	SIP025-WH
Lid for 15 and 18 Gallon Bin				SIP016-WH
Lid for 25 Gal				SIP026-WH
Bin Trolley -to suit	15/18 Gallon Bin	400mm	60mm	RBINT40ZP
Bin Trolley		350mm	60mm	RBINT35ZP
Bin trolley Heavy duty to suit	25 Gal Bin	600mm	110mm	RBINT59HZ
Ingredient bin Multibin with clear lids in trolley.Holds 3 x 45, 2 x 65, or 1 x 96 & 1 x 45 Bin combinations	3 x 42ltr	680	795 x 400	3GCMB42
Ingredient bin with hinged lid (white) on dolly	65.0 ltr	71	61 x 36	3GVIP7
Ingredient bin with hinged lid (White) on dolly	65.0 ltr	71	61 x 50	3GVIP8



JAPER-55L



SIP025-WH



RBINT59HZ



RBINT40ZP



SIP015

SIP018



SIP018



3GVIP7



3GVIP8



FHTS

TROLLEYS

Description	Dimensions	Code
Trolley with fold-down handle	45 x 70cm	FHTS
Trolley with fold-down handle	88 x 57cm	FHTL

STORAGE CONTAINERS & TROLLEYS



JAP23-341P



BUCKETS

Description	Dimensions	Code
HD Bucket & Handle white	3 G- 13ltr	SN151
Lid for 13ltr		SN148
Bucket - white	5 gallon - 22ltr	SN075-WH
Lid - white		SN073-WH
Bucket & Handle	2 Gallon - 10 tr	
Lid - white		
S/S Graduated	15.0 ltr	1QMT23003
S/S with reinforced Base	10.0 ltr	I70602
S/S Graduated	12.0 ltr	I70603
S/S with reinforced Base	15.0 ltr	Q07603
Bucket - Plastic with lid / W	5ltr	JAP23-341P
Bucket - Plastic with lid / W	10ltr	JAP23-343P
Bucket - Plastic with lid / W	20ltr	JAP23-345P



Q07603



1QMT2300



I70602



B0511PZW

10kg bags used in the photo

STORAGE PLATFORMS

Description	Dimensions		Code
	Max. Weight	Capacity	
Storage Platform	1100 x 500mm	400kg	B0511PZW
Storage Platform	1100 x 800mm	600kg	B0511PZW-HD
Storage Platform	1100 x 1100mm	1000kg	B0511PZW-MD



B1111PZW

25kg bags used in this photo



B0811PZW



B1111PZW

25kg bags used in

- ★ 100mm wheels or adjustable feet
- ★ Height off ground: 140mm
- ★ Overall height: 180mm
- ★ Manufactured from heavy duty Zinc Plated tubular frame with 1.6mm galvanised sheet platform.

THESE ITEMS MADE TO ORDER ONLY

WHEELS & ACCESSORIES

WHEELS - "D" Series		
Description	Dimensions	Code
D100 Fork Plate S/S		FD100/SP
Bolt & Nut for D series Wheel		FDBOLT
Cast Iron Wheel D Series		FDCI75
D/Cast Iron 75mm Plate		FDCI75/ZP
Heat 300 W 100 & S Spacer Hole		FDKH100/ZH
100mm Wheel Heat 300C & S		FDKT100
100mm Castor Heat 300°C		FDKT100/ZP
DNN 100 Wheel & S/S Space		FDNN100S
D Nylon 100mm Hole Mount		FDNN100S/ZH
D Nylon 100mm Hole Brake		FDNN100S/ZHTB
DNN 100 S Plate Mounted		FDNN100S/ZP
75mm Wheel & SS Spacer		FDNN75S
D75mm Nyl/W Bolt HL SWL & S		FDNN75S/ZH
D75mm Wheel Brake & Hole		FDNN75S/ZHTB
D75mm Nylon Wheels Swiv P		FDNN75S/ZP
D/Nylon 75mm Plate Brake		FDNN75S/ZPTB
D/Rubber 100mm Wheel SS		FDSA100S
D/Grey Rubber 100mm Hole		FDSA100S/ZH

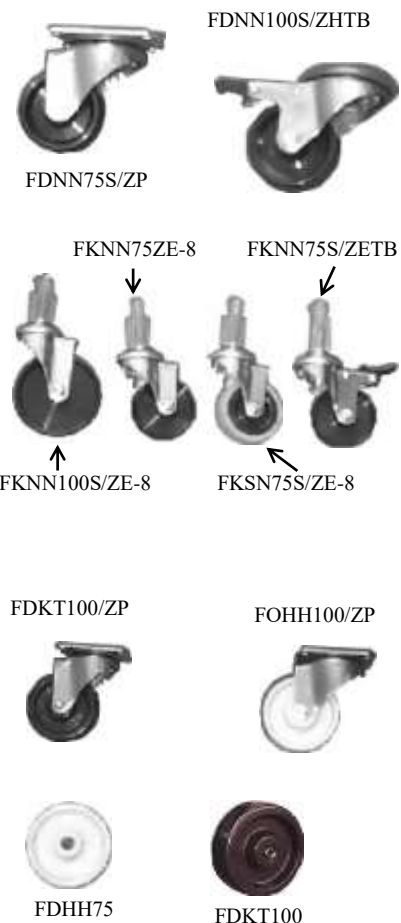

WHEELS - "K" Series		
Description	Dimensions	Code
K 100 Nylon Wheel only		FKNN100S
KNN100/E Fallshaw		FKNN100S/ZE-8
K/Nylon 75mm Wheel only		FKNN75S
75mm Castor Sq Adaptor 22		FKNN75S/ZE-8
75mm Castor Brake Sq Adap		FKNN75S/ZETB
75mm Castor Hole Mounted		FKNN75S/ZH
KNN75 Castor Plate		FKNN75S/ZP
KNN75 Castor Plate		FKSN75SZE-8
K 100mm Rubber Gray Plate		FKSN100S/ZP
K 100mm Rubber Brake Gray		FKSN100S/ZPTB



See next page for specifications

HIGH TEMPERATURE GREASE (Food Grade)		
Description	Quantity	Code
FS Extra lube (Spray) -40 to 350 deg C	400 ml	3M-2400
FS-Extra lube Tube 40 to 350 deg C	100gms	3M-2400T
Premier Lube Plus HD (Spray) 40 to 350 deg C	400 ml	3M-400
Oven Shield (Cartridge)	400 gms	3M-OS400C



FS EXTRA

Data sheet

PRODUCT DESCRIPTION

FS EXTRA is latest generation food-safe grease. Constructed using pure, non-toxic, synthetic base oils, combined with PTFE and a complex mix of antioxidant and EP packages, making FS Extra a versatile tool for use in many applications for many industries.

PHYSICAL CHARACTERISTICS

Colour	Translucent/white
Odour	None
Drop point	Non-melting
Consistency	NLGI No2
Penetration	280
Temperature range	-40 to 260°C wet condition (PTFE up to 340°C)
Water resistance	100% (hydrophobic base oil and thickener)
Lubricant solids	PTFE

PRODUCT BENEFITS

FS Extra is completely resistant to salt water and high humidity environments.

FS Extra is dielectric and can be used to protect electrical equipment from ingress of water.

FS Extra lubricates bearings, chains and sliding surfaces including plastic bearings and runners.

FS Extra has a wide temperature operating range

FS Extra is clean food safe lubricant.

METHOD OF USE

FS EXTRA is available in bulk and aerosol form. Application of bulk i.e. cartridges is by grease gun. Application of aerosol, spray 15 to 20cm from surface. Note, delivery from aerosol is in fluid form product then thickens to fully rated No2 grease allowing penetration into chain links etc.

EQUIPMENT

PASTRY SHEETER

Description	Dimensions			Code
	W	D	H	
<u>TYRONE</u> <ul style="list-style-type: none"> Bench model, 520mm wide belt; 830 table length, 415V; 375W Floor model 520mm wide belt 960 table length, 415V, 375W 	2610	940	1110	1Mminiroll520
<u>ROLLMATIC</u> <ul style="list-style-type: none"> Bench Sheeters, Manual Floor Sheeters, Manual Floor Models Available In Semi Auto & Auto 	500	700		2CSH50B
	500	900		2CSH500



1Mminiroll520



1MBAKEROLL52



2CSH500

Euromat

2CSH50B



2VVMARS

MOULDERS - DOUGH/BREAD

Description	Dimensions			Code
	W	D	H	
<u>Versatile Moulder</u> Comes with 4 piecing Attachment Run safe operator protection system two moulding belts 400 - 415v	1005	930	1970	2VVMARS
<u>Miracle Moulder</u> Comes with 4 piecing Attachment Run safe operator protection system two moulding belts 400 - 415v	630	930	1720	2VVMR300ARS
<u>Sottoriva Moulders</u> Sottoriva 4 roller crescent roll Moulder C(40), 400 - 415v	920	1110	1170	2VVFCL4



2VVMR300ARS



2VVFCL4

EQUIPMENT

PIZZA DOUGH ROLLER

Description	Code
Model 2300: S/S, two pairs of parallel & adjustable rollers, Net weight 44 kg Dough Weight 100-700 gram	2C2300/B40
Model SH500: Heavy Duty, designed for the professional who requires consistency, speed & safety, rolls up to 50 cm	2CSH500
Pizza Dough Roller: Single pass roller, S/S Body with safety Guard, 240V, 460x500x730mm, 35kg	2IDRA1035



2CSH500

2C2300/



2IDRA1035



1MBS12



2C420M



2CAV02



BREAD SLICING MACHINE

Description	Dimensions	Code
Bread slicing machine Available in 12,14,16,18,20mm etc For Slicer Stand, see "Benches	loaf passage 520mm weight 89 kg	1MBS12
Bread Slicing machine, manual Or semi automatic, slice thickness 7,9,10,11,12,14,15 & 18 mm	loaf passage 420mm, manual weight 105 kg Semi manual weight 120 kg	2C420M
Smart Slicer <ul style="list-style-type: none"> 3 speed loaf type selection control for Soft, medium or crusty bread Twin slice thickness. 12 & 15mm OR " " 13 & 17mm Meeting all Australian safety regulation	720 x 875 x 1280mm 720 x 875 x 1280mm	2VSS1215 2VSS1317

PLANETARY MIXERS

Description	Code
Planetary Mixer - 7 litre, 3 speed , dough hook, beater,	2CSH108
Planetary Mixer - 10 litre, 3 speed , dough hook, beater,	2CSH101
Planetary Mixer - 20 litre, 3 speed , dough hook, beater,	2CAV02
Planetary Mixer - 20 litre, 3 speed , dough hook, beater,	2CTS201
Planetary Mixer - 30 litre, 3 speed , dough hook, beater,	2CHUB30
Planetary Mixer - 38 litre,3 " " (ON WHEELS)	2CLD40T
Planetary Mixer - 50 litre, 3 " " Timer	2CLP402T
Planetary Mixer - 60 litre, 3 E LIFT / DOLLY ,	2CSH303E
Planetary Mixer - 80 litre, 3 E LIFT / DOLLY	2CSH306E
Planetary Mixer - 140 litre, 4 speed / E LIFT / DOLLY	2CSH-M-140W
S/S whisk & Safety Guard as standard accessories All Mixers Include Beater & Dough hook (2 YEARS WARRANTY)	

EQUIPMENT

PLANETARY

Description	Capacity	Code
Gold top Planetary Mixer (All Machines Come with Dough Hook and 25 Year Guarantee)	8Lt, (8 US quart)	1MSP800-S
	10Lt, (10 US quart)	1MSP100-S
	23 Lt, (25 US quart)	1MSP25-S
	30 Lt,(33 US quart)	1MSP30-S
	40 Lt (44 US quart)	1MSP40-S
	60 Lt (66 US quart)	1MSP60-S
	80 Lt (80 US quart)	1MSPB80-HI



1MSP800-S



1MSP100-S



1MSP25-S



1MSPB80-HI



1MSP60-S



1MSP40-S



1MSP30-S

MIXERS - DOUGH

Dimensions	Code
* Dough Mixer - 20 Kg 2 Speed spiral, Auto	2CS40N
* Dough Mixer - 25 Kg 1 Bag 2 speed spiral , Auto	2CS80N
- 50 Kg 2 bag 2 speed spiral , Auto	2CS150N
- 75 Kg 3 bag 2 speed spiral , Auto	2CS200BN
- 100 Kg 4 bag 2 speed spiral , Auto	2CS250
- 125 Kg 5 bag 2 speed spiral , Auto	2CS300
- 150 Kg 6 bag 2 speed spiral , Auto	2CS350
- 175 Kg 7 bag 2 speed spiral , Auto	2CS400
- 200 Kg 8 bag 2 speed spiral , Auto	2CS450

- S/S bowl and rear bowl guard
- Two automatic kneading speeds
- Two timers to program the working cycle
- Bowl reverse function
- All safety system to Australian OH&S standards
- Mounted on caster and lockdown bolts

Strong and reliable



2CS80N

EQUIPMENT



FIXED HEAD FIXED BOWL MIXER

	Model	Product Description	Voltage	Power	Unit Size (mm)	Kg
 <p>ITALY </p>	SMM0005	Fixed Head Fixed Bowl <ul style="list-style-type: none"> • 5kg finished product • 3 kg dry flour • Bowl 7Lt • Bowl, hook, shaft and safety guard all stainless steel • Single phase / single speed • Bowl speed 10rpm • Spiral speed 100rpm • Manufacturer Code: PK5M 	240V	0.37kW	540 x 260 x 527 Bowl Size 237 x 160	33kg

TILTING HEAD REMOVABLE BOWL

	SMM0018	<ul style="list-style-type: none"> • 15kg finished product • 10kg dry flour • Bowl 20Lt / Timer • Bowl, hook, shaft all stainless steel • Single phase / single speed • Supplied with castors • Bowl speed 10rpm • Spiral speed 100rpm • Manufacturer Code: PK18AM 	240V	0.9kW	700 x 390 x 702 Bowl Size 360 x 210	65kg
	SMM0025	<ul style="list-style-type: none"> • 20kg finished product • 12.5kg dry flour • Bowl 33Lt / Timer • Bowl, hook, shaft all stainless steel • Single phase / single speed • Supplied with castors • Bowl speed 10rpm • Spiral speed 100rpm • Manufacturer Code: PK25AM 	240V	1.1kW	770 x 430 x 790 Bowl Size 400 x 260	95kg
	SMM0044	<ul style="list-style-type: none"> • 38kg finished product • 25kg dry flour • Bowl 50Lt / Timer • Bowl, hook, shaft all stainless steel • Single phase / single speed • Supplied with castors • Bowl speed 10rpm • Spiral speed 100rpm • Manufacturer Code: PK44AM 	240V	1.5kW	860 x 530 x 790 Bowl Size 500 x 270	110kg
 <p>ITALY </p>	SMM1044	<ul style="list-style-type: none"> • 38kg finished product • 25kg dry flour • Bowl 50Lt / Timer • Bowl, hook, shaft all stainless steel • 3 phase 2 speed • Supplied with castors • Bowl speed: 1: 10rpm 2: 20rpm • Spiral speed: 1: 100rpm 2: 200rpm • Manufacturer Code: PK44AD 	400V	1.5/2.2kW	860 x 550 x 790 Bowl Size 500 x 270	140kg

FIXED HEAD – FIXED BOWL ECONOMY MODEL

 <p>ITALY </p>	SMM9925	Economy Pizza Model <ul style="list-style-type: none"> • Fixed head/bowl • 20kg finished product • 12.5kg dry flour • Bowl 33Lt / Timer • Bowl, hook, shaft all stainless steel • Supplied with castors • Bowl speed 10rpm • Spiral speed 100rpm • Manufacturer Code: IM25 	240V	1.1kW	762 x 430 x 770 Bowl Size 400 x 260	95kg
--	---------	---	------	-------	---	------

EQUIPMENT

WKPM50



WKSM7590



KitchenAid KPM50 Stand Mixer	
Height	42cm
Width	24cm
Depth	32cm
Net Weight	12.3kg
Speed Selections	10 speed solid-state control
Mixing Action	Planetary mixing action
Heavy Duty Motor	Yes
Transmission	Direct drive transmission
RPM	60-280
Construction	Die-cast metal construction
Bowl Size	4.8 Litre with handle
Mixing Capacity	Yeast dough up to a mixed weight of 1.7kg (3 x 450g loaves)
Bowl Lift	Yes
Warranty	12 Months parts and labour warranty against manufacturer's faults
Standard Inclusions	Flat beater, dough hook, stainless steel wire whisk, 2 x 4.8 litre stainless steel bowl with handle, pouring shield and bowl covers

KitchenAid KSM7590 Stand Mixer	
Wattage	500W
Height	42cm
Width	29cm
Depth	39cm
Weight Nett Gross	11.3kg
Shipping Weight	13.6kg
Speed Selections	10 speed variable
Mixing Action	Planetary
Transmission	Direct drive
RPM	40-200
Construction	Die-cast metal construction
Bowl Size	6.9L
Mixing Capacity	Yeast dough up to a mixed weight of 2.2kg (4 x 450g loaves)
Warranty	12 months parts and labour against manufacturer's faults
Standard Inclusions	Stainless Steel Flat Beater, Stainless Steel Power Knead™ Spiral Dough Hook, Stainless Steel 11-Wire Elliptical Whisk, 6.9L Stainless Steel Mixing Bowl and Pouring Shield

REFRIGERATION / FREEZING

FREEZERS

Description	Dimensions(mm)	Code
<u>FLAT GLASS FREEZERS</u>	715 x 435 x 790 mm	TEF110- 4FG
Available in 5 Different sizes:	885 x 610 x 790 mm	TEF230-8FG
Temperature Range, Control	1220 x 610 x 790 mm	TEF320-13FG
Temperature Range, Control	1465 x 660 x 790mm	TEF500-18FG
Temperature Range, Control	1800 x 660 x 790 mm	TEF600-23FG
<u>CURVE GLASS</u>		
Available in 5 Different sizes:	885 x 610 x 715 mm	TEF230-8CG
	1035 x 610 x 715 mm	TEF270-11CG
	1220 x 610 x 715 mm	TEF320-13CG
	1465 x 660 x 705 mm	TEF500-18CG
	1800 x 660 x 705 mm	TEF600-23CG
Features Include: Temperature Range, Control Defrost System Standard Accessories Optional Accessories Optional Basket Divider		



TEF320-13FG



TEF230-8CG

ICE CREAM CANOPY FREEZER

Description	Dimensions(mm)	Code
Available in 4 Different sizes:	885 x 610 x 1361 mm	TEF230-8FGC
	1220 x 610 x 1361 mm	TEF320-13FGC
	1465 x 660 x 1361 mm	TEF500-18FGC
	1800 x 660 x 1361 mm	TEF600-23FGC
Features Include: Temperature Range, Control Defrost System Standard Accessories		



TEF230-

REFRIGERATION / FREEZING

DISLPAY CHILLERS/DOUBLE & SINGLE SIZES

Description	Dimensions(mm)	Code
<u>DOUBLE DOOR</u>		
With light Panel	1130 x 710 x 2195 mm	TSCD1000P
Adjustable Grid Shelf	658 Watts	
Temperature Range, Control	1000 ltr	
Digital Thermometer, Key lock Castor Wheel		
<u>SINGLE DOOR</u>		
Available in 4 Different Models	580 x 583 x 1855 mm	TSCD270P
With light Panel	160 Watts	
Adjustable Grid Shelf	268 ltr	
Temperature Range, Control Standard Accessories	610 x 685 x 1930 mm	TSCD360P
Digital Thermometer, Key lock	185 Watts	
Castor Wheel	358 ltr	
	610 x 760 x 2060 mm	TSCD510P
	275 Watts	
	506 ltr	
	765 x 760 x 2060 mm	TSC660P
	342 Watts	
	660 ltr	



TSCD1000P



TSCD510P



TCTD78
TCTD78-LED



TCTD235



TCTD78L
TCTD78L-LED

COUNTER TOP CHILLERS

Description	Dimensions	Code
Available in White / Black	430 x 425 x 940 mm	TCTD78
Adjustable 3 Grid Shelf		
2Curved Front & back with	430 x 425 x 940 mm	TCTD78L-LED
Four side glass		
Temperature Range, Control		
Standard Accessories		
Internal Light flush with the ceiling	430 x 425 x 940 mm	TCTD78L
LED flush down with the sides	430 x 425 x 940 mm	TCTD78L-LED

SHOWCASE REFRIGERATORS

Description	Dimensions(mm)	Code
Showcase Refrigerator 235 L	520wx480Dx1840Hmmm	TCTD235
4 Shelf + Floor		
Double glazed		
Power 210W		

COOKING POTS & PANS

STOCK POTS				
Description		Dimensions(mm)		Code
		Diameter	Depth	
Aluminum	Premier	8.0 ltr	230 185	Q60808
"	"	10.0 ltr	240 215	Q60810
"	"	12.0 ltr	250 240	Q60812
"	"	16.0 ltr	280 255	Q60816
"	"	20.0 ltr	300 280	Q60820
"	"	24.0 ltr	320 290	Q60824
"	"	32.0 ltr	350 320	Q60832
"	"	40.0 ltr	370 365	Q60840
"	"	50.0 ltr	405 385	Q60850
"	"	60.0 ltr	440 405	Q60860
"	"	80.0 ltr	480 430	Q60880
"	"	90.0 ltr	510 450	Q60890
"	"	120.0 ltr	550 495	Q60920
"	"	140.0 ltr	580 519	Q60940
S/S with Lid	Robinox	8.0 ltr	240 205	2ZWSS08
"	"	12.0 ltr	260 225	2ZWSS12
"	"	16.0 ltr	280 260	2ZWSS16
"	"	20.0 ltr	320 260	2ZWSS20
"	"	24.0 ltr	340 260	2ZWSS24
"	"	36.0 ltr	360 360	2ZWSS36
"	"	50.0 ltr	400 400	2ZWSS50
"	"	70.0 ltr	450 450	2ZWSS70
"	"	98.0 ltr	500 500	2ZWSS98
18/10 S/S with Tap & Cover		33.6 ltr	350 350	I9248-035
"	"	50 ltr	400 400	I9248-040
"	"	72 ltr	450 450	I9248-045



CASSEROLE POTS-S/S					
Description		Dimensions		Code	
		Capacity	Diameter	Height	
Casserole High - including lid	Robinox	2.4 ltr	160	120	2ZCH2
"	"	4.4 ltr	200	140	2ZCH4
"	"	7.2 ltr	240	160	2ZCH7
"	"	11.1 ltr	280	180	2ZCH11
Casserole Low - including lid	Robinox	3.3 ltr	200	105	2ZCL3
"	"	5.0 ltr	240	110	2ZCL5
"	"	8.0 ltr	280	130	2ZCL8
"	"	12.9 ltr	320	160	2ZCL13

SAUCE POTS				
Description		Dimensions(mm)		Code
H/D Aluminium - includ. Lid		15.0 ltr	300 200	Q60715
"	"	20.0 ltr	320 240	Q60720
"	"	25.0 ltr	350 255	Q60725
"	"	32.0 ltr	405 250	Q60732
"	"	50.0 ltr	480 290	Q60750

COOKING POTS & PANS



I61107



I61320



Q06118

2ZFP24



3A1130

3A1138



Q05224



Q07780



Q06001

FRYING PANS		
Description	Dimensions	Code
Non stick	180mm 200mm 250mm 300mm 350mm	I61107 I61108 I61110 I61112 I61114
Sauté pan, Aluminium	200mm 250mm 300mm 350mm	I61320 I61325 I61330 I61335
S/S Frying Pan - 1.25 ltr Robinox	200mm	2ZFP20
“- 2.0 ltr “	240mm	2ZFP24
“ 3.0ltr “	280mm	2ZFP28
“ 3.75ltr “	320mm	2ZFP32
“ 5.0ltr “	360mm	2ZFP36
“ 6.25ltr “	400mm	2ZFP40
Aluminium Fry Pan - Tapered Sides	180mm	Q06118
Available in Different Sizes	200mm 250mm 300mm 350mm	Q06120 Q06125 Q06130 Q06135

WOK		
Description	Dimensions	Code
Non Stick Wok	360 mm	3A1130
Wok Lid	360	3A1138
Wok - Iron	350mm (14in) 400mm (16in) 450mm (18in) 500mm (20in) 600mm (24in)	Q05214 Q05216 Q05218 Q05220 Q05224

Roast Pan Non-Stick / S/S		
Description	Dimensions	Code
Teflon Platinum non AL stick multilayer Professional quality coating for high Performance cookware	450 x 350 x 80mm	Q63636
Roasting Pan S/S	410 x 310 x 75mm	Q07780

HD Aluminum SAUCE POTS / SAUCEPAN				
Description	Dimensions			Code
Aluminium Saucepan with Tapered Sides	1.5 ltr	160	100	Q06001
	2.5 ltr	200	110	Q06002
	3.5 ltr	220	110	Q06003
	4.5 ltr	240	120	Q06004
	5.5 ltr	250	140	Q06005
	7.0 ltr	260	140	Q06007
	10 ltr	300	150	Q06010

ELECTRIC BENCH TOP EQUIPMENT

BOILING HOT PLATES					
Description	Dimensions(mm)				Code
	Hot Plate Diam.	W	D	H	
6 heat settings, 2000 watts	1 x 190	300	255	105	2Z11
6 heat settings, 2400 watts	2 x 150	510	265	105	2Z12
6 heat settings, 2000 watts	1 x 230	360	282	105	2Z13



2Z11



2Z12

URNS - S/S				
Description	Dimensions			Code
	Cap. 230ml Cups	D (mm)	H (mm)	
10 litre capacity, 2400 watts	50	252	385	2ZLT10
20 litre capacity, 2400 watts	100	310	462	2ZLT20
30 litre capacity, 2400 watts	150	360	500	2ZLT30



RICE COOKER / WARMER	
Description	Code
Ideal solution for cooking Simple one-touch solution, automatic shut-off 5.4ltr, 30 cup capacity	2ZSW5400
Ideal solution for both cooking & Keeping warm Easy one-touch operation, non-stick coated bowl, auto shut off 6 ltr, 33 cup capacity	2Z SW6000



2ZSW5400



2ZSW6000

SOUP KETTLE		
Description	Code	
Simple to use and attractive styling	10 ltr Capacity	2ZSW1200
Durable and power-saving design	H: 370 x Dia: 405	
Easy to take apart for cleaning		



2ZSW1200

STEAMER			
Description	Dimensions(mm)		Code
	D	H	
Suitable for vegetables, dim sims & all types of foods. S/S construction, S/S basket, boil dry protection, 2400 watts.	305	270	2ZSC1



2ZSC1

ELECTRIC BENCH TOP EQUIPMENT



2ZKH2

COFFEE WARMER

Description	Dimensions (mm)			Code
	Height	Width	Depth	
S/S body, 2 On/Off switches, 250 watts	75	385	220	2ZKH2

BOEMA COFFEE EQUIPMENT

Description	Code
<p>AUSTRALIAN MADE Boema Coffee Machines, Available in Semi Automatic & Volumetric Also Available in ORIGINAL, DELUXE & MAESTRO Models</p> <p>Single Group</p> <p>Two Group</p> <p>Three Group</p> <p>Boema Coffee Grinder: Fully Automatic with dosage to group cup</p>	



CHAFING DISH/HEATER

Description	Dimensions	Code
Chafing Dish Chafing Dish Heater (electric) - Suitable for linking (HP9B model only)	615 x 360 x 320 465 x 125 x 85	



BAIN MARIES - Counter Top

Description	Dimensions (mm)			Code
	Height	Width	Depth	
<p>Model 100 - Max. pan depth 150mm No pans 1 x ½ size 100mm pan & lid 1 x ½ size 150mm pan & lid 1 x 200mm round (7.25L) pot & lid</p>	305	345	285	2Z100 2Z100A 2Z100B 2Z100E
<p>Model 200 - Max. pan depth 150mm No pans 2 x ½ size 100mm pans & lids 3 x 1/3 size 100mm pans & lids 3 x 1/3 size 150mm pans & lids 2 x 200mm round (7.25L) pots & lids</p>	305	345	285	2Z200 2Z200A 2Z200B 2Z200C 2Z200E
<p>Model 205 - Max. pan depth 150mm No pans 4 x ½ size 100mm pans & lids 6 x 1/3 size 100mm pans & lids 6 x 1/3 size 150mm pans & lids 4 x 200mm round (7.25L) pots & lids</p>	305	665	545	2Z105 2Z105A 2Z105B 2Z105C 2Z105E



2Z100



2Z200



2Z105A

- Designed to hold food at serving temperature.
- S/S construction
- Incoloy metal elements with energy regulator control
- Removable cross bars
- 12.7mm drain
- Wet or dry operation
- Takes many combinations of gastronorm pans

ELECTRIC BENCH TOP EQUIPMENT

TOASTERS - High Speed Grill - Also available on Teflon not stick

Description	Dimensions (mm)			Code
	Height	Width	Depth	
Model TX4 • S/S construction with cast aluminium cooking plates • Thermostat control • Removable grease box • Self adjusting height for different food thicknesses • 2400 watts Toast up to 6 sandwiches at once	240	400	490	2ZTX4
Model CGS810 Available with smooth plate or grooved plate • S/S construction • Cast aluminium cooking plates for fast & even heat transfer • Thermostat control • Adjustable plate height • 2400 watts • Toast up to 8 sandwiches at once • Splash guard	240	500	520	2ZCGS810



2ZTX4



2ZCGS810

TOASTERS - Conveyor

Description	Dimensions (mm)			Code
	Height	Width	Depth	
Model TCR10 (Up to 300 Slices/hour, 10 amp)	370	475	430	2ZTCR10
Model TCR15 (Up to 500 Slices/hour, 15 amp)	370	475	430	2ZTCR15
Features: • Incoloy metal elements • Removable crumb tray • Warming toast rack • S/S construction • Removable entry chute • Variable electronic conveyor speed • Fan cooled motor & controls *Chute not included				



2ZTCR10



2ZTC55



2ZS15

TOASTERS

Description	Dimensions (mm)			Code
	Height	Width	Depth	
Vertical Toaster Model TC55 (2400W) Model TC66 (2800W)	410	295	230	2ZTC55 2ZTC66
Features: Accommodate up to 6 slices Automatic element timer for consistent results 5 min timer, Easy-clean crumb tray Multi-slice selection				
Automatic Toaster Model S15	705	425	370	2ZS15
Features: Ideal for grilled foods Top & bottom or top only heat selection 6-15 bread slice options available 10 & 15Amp option				

ELECTRIC BENCH TOP EQUIPMENT

ROTISSERIE

Description	Dimensions (mm)			Code
	Height	Width	Depth	
Model R10 3,600 Watts (15 Amps)	671	1180	349	2ZR10



2ZR10

MEAT SLICER

Description	Dimensions (mm)			Code
	Height	Width	Depth	
FOOD SLICERS				
Three sizes (diameter) available:				
220mm	420	510	340	2ZNS220
250mm	420	520	360	2ZNS250
300 mm	530	600	460	2ZNS300
Extra Heavy Duty Food Slicers				
Two sizes (diameter) available:				
300mm	570	620	430	2ZNS300HD
350mm	630	720	450	2ZNS350HD
Automatic Food Slicer Easy to read digital	870	670	600	2ZNSA350258



2ZNS220

GRIDDLE HOTPLATES

Description	Dimensions (mm)				Code
	Cooking Surface	Height	Width	Depth	
2400W	520 x 330	235	585	395	2ZHP505A
3300W	520 x 330	235	585	395	2ZHP505B
3300W	520 x 330	235	585	395	2ZHP505C*
4800W	690 x 410	235	750	500	2ZHP1505A
6000W	690 x 410	235	750	500	2ZHP1505B
6000W	690 x 410	235	750	500	2ZHP1505C*

*2ZHP505C & 2ZHP1505C come with half grooved plate

- S/S construction
- Forward drain gutter
- Thermostat control



2ZNS300HD



2ZNSA350



2ZHP505C



2ZHP1505A/B



2ZHP1505A/B

BENCH TOP/MINCING EQUIPMENT

MEAT MINCER				
Description	Dimensions (mm)			Code
	Height	Width	Depth	
<p><u>Light Duty Meat Mincer</u> <u>Features:</u> S/S Body Detachable aluminium tube Sausage & Kubbe attachments Cutting plate (fine, medium, coarse) Easy to clean</p>	470	240	280	1MSM-G73
<p><u>Heavy Duty Meat Mincer</u> Suitable for meat, bone less chicken/fish Also suitable to puree tomato 220kg/hr</p>	500	280	486	2LTX800



1MSM-G73



2LTX800



1BMO547



1B07PT599



1B07PT572



1B07PT580

GRINDERS AND MINCERS			
Description	Dimensions (mm)		Code
	Diameter	Length	
<p>Mondo Grinder: Available in 6 different sizes No. 8 No. 10 No. 22 No. 32</p>	85 90 110 125	165 185 185 185	1BMO547 1BMO548 1BMO549 1BMO550
<p>Sausage attachment (To suit no. 10 mincer) Also available for all sizes</p>	10 20		1B07PT599 1B07PT600
<p>Mincer discs</p> <p>To suit no. 10 To suit no. 22 To suit no. 32</p>	3.0 4.5, 6, 8, 10, 12, 14, 16, 18 3.0 4.5, 6, 8, 10, 12, 14, 16, 18 3.0 4.5, 6, 8, 10, 12, 14, 16, 18, 20		1B07PT572 1B07PT573 1B07PT574 1B07PT575 1B07PT576 1B07PT577
<p>Knife 4 Blades No: 10 Knife 4 Blades No: 22 Knife 4 Blades No: 32</p>			1B07PT580 1B07PT581 1B07PT582

ELECTRIC BENCH TOP EQUIPMENT



2ZBF1



2ZF1

<i>FRYERS</i>							
Description	Basket Dimensions (mm)			Machine Dimensions (mm)			Code
	Height	Width	Depth	Height	Width	Depth	
1 tank, 1 basket	145	195	215	340	273	425	2ZF15
1 tank, 2 baskets	145	120	215	340	363	425	2ZF17
1 tank, 1 basket	145	195	215	390	273	425	2ZF18
1 tank, 2 baskets	145	195	215	340	538	425	2ZF111
2 tanks, 2 baskets	145	195	215	340	538	425	2ZF25
2 tanks, 2 baskets	145	195	215	390	538	425	2ZF28

- Precise thermostat control
- Isolating switch
- Tank cover
- S/S construction
- Swing back elements
- Recess/handle to enable easy removal of tank
- Insulated basket handle
- Adjustable feet
- Maximum & minimum oil level markers
- Element guard and capillary protection



2ZF111



2ZF25

ELECTRIC BENCH TOP EQUIPMENT

<i>CHOCOLATE DIPPING MACHINES</i>				
Description	Dimensions (mm)			Code
	Height	Width	Depth	
Water heated, 1400W 15kg chocolate capacity	191	505	346	1R260115
Air heated, 300W 15 kg chocolate capacity	240	540	360	1R260215
S/S bowl, 200W, 3.5 litre capacity Temp. range 25oC-90oC	188	254 (dia)	N/A	1R260432



1R260215

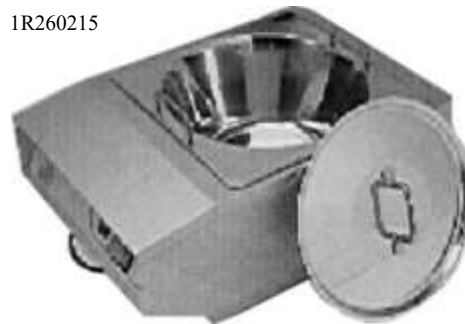

<i>CHOCOLATE TEMPERING MACHINE</i>				
Description	Dimensions (mm)			Code
	Height	Width	Depth	
Water heated chocolate tempering machine 1800W, 22 litre capacity	210	790	385	1R260322

ELECTRIC BENCH TOP EQUIPMENT

<i>BAIN MARIES - Chocolate Tempering</i>				
Description	Dimensions (mm)			Code
	Height	Width	Depth	
Designed to melt and hold chocolate at a predetermined temperature suitable for food coating operations.				
Model 102A	305	345	285	2Z102A
Model 202A	305	550	345	2Z202A
<ul style="list-style-type: none"> • S/S construction • Thermostatically controlled (0 - 50°C) • Takes combinations of gastronorm pans 				



2Z102A



2Z202A

ELECTRIC BENCH TOP EQUIPMENT

GRIDDLE HOTPLATES/TOASTERS

Description	Cooking Surface Dimensions (mm)	Overall unit Dimensions (mm)			Code
		Height	Width	Depth	
2400 watts	520 x 330	320	585	395	2ZHP605A
3300 watts	520 x 330	320	585	395	2ZHP605B
4800 watts	690 x 410	320	750	500	2ZHP1500A
6000 watts	690 x 410	320	750	500	2ZHP1500B

- S/S construction
- Forward drain gutter
- Thermostat control
- Utilise hot plate elements for toasting



2ZHP1500A/B



2ZHP605A/B

SALAMANDER

Description	Dimensions (mm)			Code
	Height	Width	Depth	
3200 watts	347	705	425	

- S/S construction
- 15 slice capacity
- Removable drip/crumb tray
- Dual energy regulator control for left & right side elements



2ZS15

ELECTRIC BENCH TOP EQUIPMENT

<i>DOUGHNUT FRYER, DROPPERS & STANDS</i>				
Description	Dimensions (mm)			Code
	Height	Width	Depth	
Doughnut Fryer: 8.5 ltr tank capacity, 2 baskets	290	380	485	2ZFD10
Doughnut Dropper				2ZWA-K
Stand for Dropper				2ZWA-S
Pancake Dropper				2ZWA-KP
Doughnut Maker (Plastic)	180	100		3A2817



2ZFD10



3A2817



2ZWA-K &
2ZWA-S

DEEP FRYER BASKET / LIFTERS / SKIMMERS

<i>LIFTERS & SKIMMERS</i>		
Description	Dimensions (mm)	Code
Lifter: Square - S/S	155 200	K1229 I30510
Skimmer: Round -H/D - D Mesh	140 160 200 280	Q02524 Q02416 Q02520 Q02428
Skimmer: Round 18/10 Wire	125 155	Q38000 Q38002
Skimmer: Spiral 18/10 Wire	140 160 180 200	I30414 I30416 I30418 I30420
Skimmer: Square	150 200	I30476 I30486



Q38000/38002

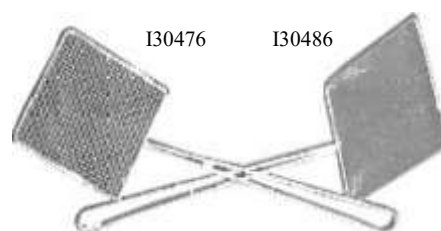

I30476 I30486



Q02428



Q02428



K1229

DEEP FRYER BASKET/LIFTERS/SKIMMERS

DEEP FRYER BASKETS					
Description	Fryer	Dimensions (mm)			Code
		Length	Width	Depth	
Rect. Fry Baskets	Woodson	225	200	150	I30640
	Luke	155	200	150	I30641
		325	135	150	Q02755
	Waldorf	325	175	150	I30642
	Goldstein	350	125	150	I30643
		375	125	150	I30644
Round Fry Baskets			155	150	I30615
			200	155	I30620
			250	155	I30625
			300	155	I30630
			250	150	Q02725

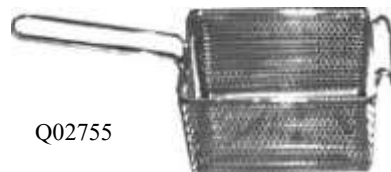
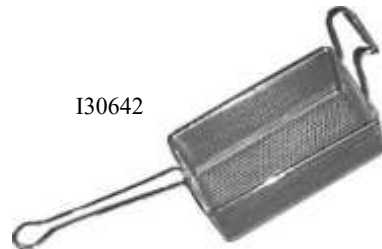
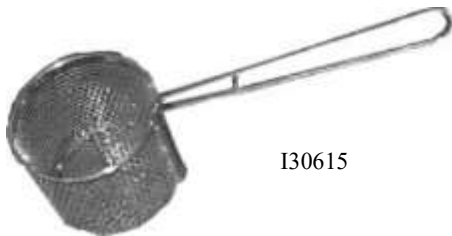

1B08M0520

GAS EQUIPMENT

Gas Cookers—LPG/Natural Gas

Description	Dimensions (mm)	Code
Single burner	260 x 280	1JIF-100C
Double Burner	520 x 280mm	1JIF-200C
Triple Burner	780 x 280mm	1JIF-300C
1 Ring Burner	85mm ring width	1JIF-20-1
2 Ring Burner	165mm	1JIF-30-1
3 Ring Burner	220mm	1JIF-40-1
4 Ring Burner	330mm	1JIF-50-1
Wok Burner—High pressure (LPG only) (includes High Press. Reg. & hose)	top 320 mm	1JWOK-KIT2
Wok Burner — Single Head	290 x 375mm	1JRB-18NG
Double head	375 x 720mm	1JRB-28NG
(Available in Natural & LPG)		
Wok Kit — High Press Double Ring LPG Gas	420Dia. x 230H	1JWOK-KIT2



1JIF-200C



1JIF-100C

1JIF-50-1



1JRB-18NG



1JRB-28NG

1JWOK-KIT2



GAS EQUIPMENT

Gas Regulators & Hoses

Description	Dimensions	Code
Gas Hose	1.2 metres	1J1322-4
LPG Regulator—Low pressure		1J7010-1



1J7010-1



1J1322-4

FLEXIFLAME Gas Lighter

Description	Dimensions	Code
High quality Flexi Flame BBQ Lighter	30 x 255mm long	1B08M0520



1B08M0520

KITCHEN UTENSILS

WHISKS—PIANO WIRE

Description	Dimensions	Code
Heavy Duty, Stainless Steel	25cm (11")	Q036725
	35cm (14")	Q036735
	40cm (16")	Q036740
	45cm (18")	Q036745
'Loyal' 12-Wire	30cm	2ULW12930
	35cm	2ULW12935
	40cm	2ULW12940
	45cm	2ULW12945



WHISKS—FRENCH H/D, S/S

Description	Dimensions	Code
French H/D S/S 8 wire	30cm (12")	Q036630
	35cm (14")	Q036635
	40cm (16")	Q036640
	45cm (18")	Q036645
	50cm (20")	Q036650
	55cm (22")	Q036655
	60cm (24")	Q036660
	61cm	PWSK610
	66cm	PWSK660
'Loyal' 8-Wire	30cm (12")	2ULW81130
	35cm (14")	2ULW81135
	40cm (16")	2ULW81140
	45cm (18")	2ULW81145
	50cm (20")	2ULW81150
	55cm (22")	2ULW81155
	60cm (24")	2ULW81160



2U codes

Q36645



Q36650

Q36635

WHISKS—MATFER - EXOGLASS

Description	Dimensions	Code
S/S - 16 wires	25cm	1R111022
	30cm	1R111023
	35cm	1R111024
	40cm	1R111025
	45cm	1R111026
	50cm	1R111027
		45cm
S/S - 24 wires	45cm	1R111046

1R11026

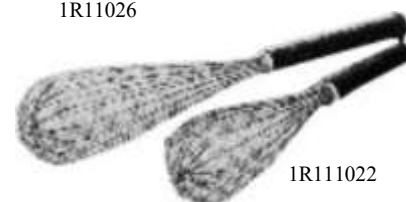

1R11022

WHISKS—GOURMET S/S

Description	Dimensions	Code
Gourmet S/S	255mm	Q32420
	305mm	Q32421
	355mm	Q32422



Q32422

KITCHEN UTENSILS

2ULW41425

2ULW42330

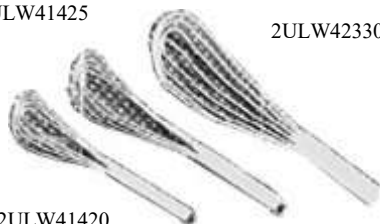

2ULW41420



K29W6



K1256



Q03451



1R113330

WHISKS—SPOON

Description	Dimensions	Code
'Loyal' 4-wire Piano Whisk	20cm 25cm	2ULW41420 2ULW41425
'Loyal' 4-wire Heavy Duty French Whisk	30cm	2ULW42330

WHISKS—ASSORTED

Description	Dimensions	Code
Heavy Duty Pie Whisk	610mm	K29W6
Drill Whisk	410mm 685mm	K1256 K1257

SPOONS—WOODEN & HIGH TEMP PLASTIC

Description	Dimensions	Code
Wooden	250mm 300mm 350mm 400mm 450mm 500mm	Q03451 Q03452 Q03454 Q03456 Q03458 Q03460
Exo-glass—3 different colours	300mm 380mm 450mm	1R113330 1R113338 1R113345

PADDLES

Description	Dimensions	Code
S/S Paddle-H/D	600mm 750mm 900mm 1200mm	Q03402 Q03403 Q03404 Q03406
Wooden H/D	450mm (18") 500mm (20") 600mm (24") 750mm (30") 900mm (36") 1050mm (41")	Q03418 Q03420 Q03424 Q03430 Q03436 Q03442
Plastic HACCP Approved	125 x 1190mm	HHCHW81



Q03402



Q03420



HHCHW81

BUTTER/SANDWICH SPREADERS

Description	Dimensions	Code
Butter Spreader (S/S)	10.5cm	Q03035
Sandwich Spreader (S/S)	8.5cm	Q03185
Straight Spatula	10cm	2UT101-4

2UT101-4



Q03035

KITCHEN UTENSILS

SANDWICH GUARD

Description	Dimensions	Code
1/8 Stainless Steel Sandwich Guard	135mm x 135mm	Q07280

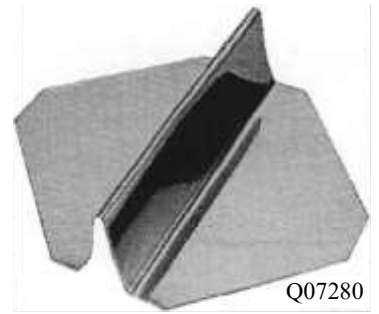

LADLES—STAINLESS STEEL

Description	Dimensions	Code
Ladle—1pc	30ml	Q36001
	60ml	Q36002
	120ml	Q36004
	180ml	Q36006
	240ml	Q36008
	360ml	Q36012
Ladle—1pc H/D	250ml	Q30103
	500ml	Q30104
	750ml	Q30105
	1.2L	Q30106
Skimmer S/S	100mm x 230mm	I78660



BASTING/SERVING SPOONS

Description	Dimensions	Code
Stainless Steel Solid	280mm	Q03311
	330mm	Q03313
	380mm	Q03315
Stainless Steel Perforated	280mm	Q03321
	330mm	Q03323
	380mm	Q03325
Stainless Steel Slotted	280mm	Q03331
	330mm	Q03332
	380mm	Q03335
Polycarbonate (Plastic) Solid, White	275mm	Q43011-W
Cream/Rice Spoon		W20138



GARLIC PRESS

Description	Dimensions	Code
S/S Jumbo Size	65mm x 200mm	3A3630
Standard	50mm x 155mm	1F1053



KITCHEN UTENSILS

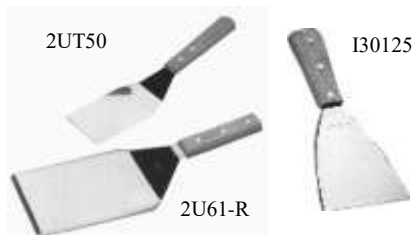

2UT50

I30125



2U61-R

Q03008



I30116



I30119



I30120

I30139

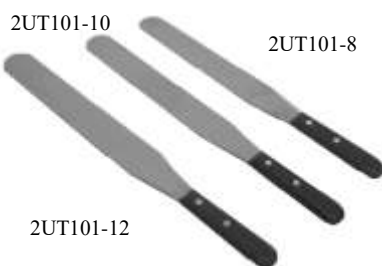

2UT101-10

2UT101-8

2UT101-12



A5.2603.12

A5.2603.18



A5.2603.23

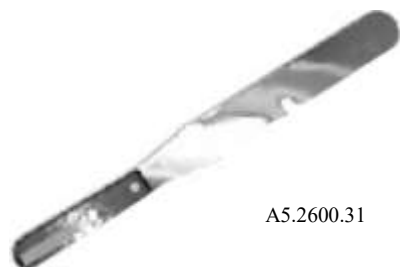

A5.2600.31

TURNERS/SCRAPERS

Description	Dimensions (mm)	Code
Flexible S/S	175 x 120	Q03019
	95 x 105	Q03008
Burger S/S	125 x 155	Q03020
Flexible - Wood Handle	76 x 200	Q03023
Turner/Server	200 x 73	2UT50
Hamburger Turner - rounded blade	360	2UT60-R
Turner - H/D, bevelled front	160 x 110	2UT61-R
Turner - H/D, bevelled edges	180 x 70	2UT62-R
Turner - H/D, bevelled edges	220 x 130	2UT64-R
Scraper Griddle	95 x 105	Q03030
S/S Griddle Scraper, plastic handle	125 x 75	I30116
S/S Griddle Scraper, plastic handle	110 x 95	I30119
S/S Pan Scraper, wood handle		I30125
S/S Flexible Turner, wood handle	245 x 75	I30141
S/S Flexible Turner, plastic handle	245 x 75	I30142
S/S Giant Hamburger Turner, wood handle	170 x 125	I30120
S/S Flexible Turner, plastic handle	195 x 100	I30139
S/S Flexible Turner, perforated	125 x 90	I30108
S/S Solid Flexible Turner	150 x 75	I30106
S/S Slotted Flexible Turner	150 x 75	I30107

SPATULAS - FLAT/STRAIGHT

Description	Blade Dimensions (mm)	Code
Wooden Handle - Loyal	100 x 19	2UT101-4
	150 x 27	2UT101-6
	200 x 30	2UT101-8
	300 x 45	2UT101-12
Nylon Handle (narrow blade) - Victorinox	100 x 17	A5.2603.10
	120 x 23	A5.2603.12
	150 x 25	A5.2603.15
	200 x 32	A5.2603.20
	230 x 33	A5.2603.23
	250 x 35	A5.2603.25
	310 x 42	A5.2603.31
Nylon Handle - Loyal	100 x 19	2UT201-4
	150 x 27	2UT201-6
	200 x 30	2UT201-8
	250 x 37	2UT201-10
	300 x 45	2UT201-12

KITCHEN UTENSILS

SPATULAS—ANGLED

Description	Blade Dimensions (mm)	Code
Wooden Handle - Victorinox	200 230 250 310	A5.2700.20 A5.2700.23 A5.2700.25 A5.2700.31
Nylon Handle (Black) - Victorinox	250	A5.2703.25
Wooden Handle - Loyal - angle	150 x 27 200 x 31 250 x 40 300 x 45	Q223142U Q223082U Q223102U Q223122U
Nylon Handle (Black) - Loyal	100 x 190	2UT203-4
Nylon N/S Spatula	90 x 55 x 335	Q32617
Nylon Handle—Square Edge—Victorinox	160	A5.2763.16

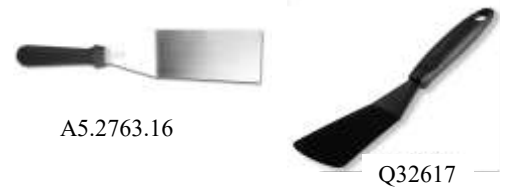
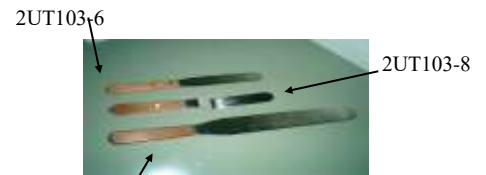

SPATULAS/SCRAPERS

Description	Length (mm)	Code
Rubber scraper - S/S handle (Loyal)	200 260 320	2ULS4720 2ULS4726 2ULS4732
Spatula - flat "Exoglass" 220°C (Matfer)	350	1R113501
Spatula Rubber Thermo 110°C (Matfer)	250 350 450	1R113525 1R113535 1R113545
Spatula "Exoglass" 220°C (Matfer)	250 300 350 400 450 500	1R113025 1R113030 1R113035 1R113040 1R113045 1R113050
Spatula "ELVEO" 260°C (Matfer)	250 285 350	1R113724 1R113725 1R113735



EGG SLICER

Description	Dimensions (mm)	Code
H/D high polished aluminum egg slicer	120 x 110	QO3121
Duplex egg slicer, cast alloy, H/D Suitable for mushrooms	120 x 95	1F4666



EGG WEDGER/CUTTER

Description	Dimensions (mm)	Code
Stainless Wire Cast Aluminum Body with Food Safe Coating Dishwasher Safe Cuts into 6 equal segments	180 x 65	I37523



KITCHEN UTENSILS



1F985105-1F985109



2ULP29010

3A4415



Q03112



1R122031

MIXING BOWLS

Description	Dimensions	Code
Stainless Steel - Round Bottom	160mm—0.6lt	Q07201
	195mm—1.1lt	Q07202
	235mm—2.2lt	Q07203
	285mm—3.6lt	Q07205
	340mm—6.5lt	Q07208
	370mm—8.0lt	Q07209
	410mm—10lt	Q07213
	445mm—13lt	Q07217
	470mm—17lt	Q07220
	Stainless Steel - Tapered	160mm—1.0lt
200mm—2.0lt		Q07381
240mm—2.5lt		Q07382
280mm—4.5lt		Q07383
320mm—6.0lt		Q07384
360mm—9.0lt		Q07385
400mm—14lt		Q07386
Stainless Steel Deep Heavy Duty		158mm—0.9lt
	208mm—1.8lt	Q70502
	213mm—2.8lt	Q70503
	245mm—3.75lt	Q70504
	270mm—5.75lt	Q70505
	300mm—7.5lt	Q70508
	360mm—11.5lt	Q70512
	Stainless Steel Contemporary Design Mirror finished interior and Satin finished exterior.	180mm—1.4lt
220mm—2.8lt		1F985106
260mm—5lt		1F985108
300mm—7.5lt		1F985109

MIXING BOWLS (poly)

Description	Dimensions	Code
Plastic poly (Microwavable) Dishwasher Safe, Flat Base Available in many sizes	160mm—1 ltr	2ULP29010
	200mm—2.5ltr	2ULP29025
	240mm—4.5ltr	2ULP29045
	285mm—6 ltr	2ULP29060
	320mm—8 ltr	2ULP29090
	355mm—13 ltr	2ULP29130

MIXING BOWLS (plastic)

Description	Dimensions	Code
Plastic bowl (set)	1.5ltr, 2.0ltr & 2.2ltr	1F985112

GRATER

Description	Dimensions	Code
Grater 4 Sided S/S Deluxe	110x85mm —185mm (high of grater)	3A4415

CHEESE SLICER/WIRE (Cheese knife can be found on page 2704)

Description	Dimensions	Code
Cheese Slicer S/S	250x130mm	Q03112
Cheese Wire cutter	800mm	1R122031

KITCHEN UTENSILS

SIEVES & SIFTERS

Description	Dimensions (mm)	Code
Drum Sieve—Bread	300 350	QPD2604-30 QPD2604-35
Drum Sieve—Flour	300 350	QPD2605-30 QPD2605-35
Drum Sieve—General	300 350	QPD2606-30 QPD2606-35
Sieve- S/S Mesh		
Sugar	185 (No.40)	Q31110
Flour	305 (No.12) 305 (No.24)	Q31116 Q31118



SIEVES—S/S		
Description	Dimensions	Code
S/Steel rim and mesh	250mm 300mm 350mm 400mm	Q39310 Q39312 Q39314 Q39316



SIFTERS—Flour	
Description	Code
S/S 5 cup - triple screen - squeeze handle	3D13633
S/S 5 cup - crank handle	3A2806



STRAINERS		
Description	Dimensions	Code
18/8 Gourmet Fine Mesh - S/S	140mm 160mm 200mm	Q32412 Q32413 Q32414
18/10 Fine Mesh Professional	150mm 200mm	Q33150 Q33200



KITCHEN UTENSILS

STRAINERS/OIL FILTERS—Conical

Description	Dimensions	Code
18/8 Course Mesh	180mm	Q03867
	200mm	Q03868
	230mm	Q03869
	250mm	Q03870
	300mm	Q03872
18/8 Fine Mesh	180mm	Q03847
	200mm	Q03848
	230mm	Q03849
	250mm	Q03850
	300mm	Q03852
Oil Filter Rack	L 240mm x D 210mm	Q03679
Oil Filter Paper - Regular (50's)	L 250mm x D 350mm	Q03678
Oil Filter Paper - Large (50's)	L 295mm x D 410mm	Q03680
Oil Filter Mira Nylon Square	L 690mm x 245mm	K1355



Q03869



Q03849



I61800

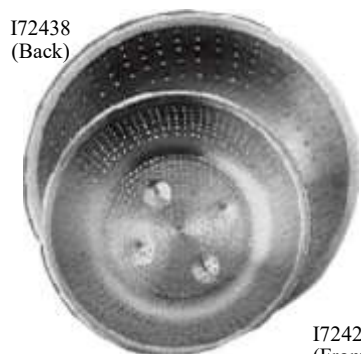

I72438
(Back)

I72427
(Front)



Q07405



Q03679

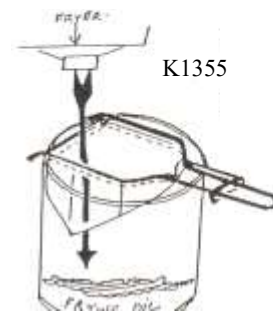

K1355

COLANDERS

Description	Dimensions	Code
Stainless Steel	290mm—5.0lt	Q07405
	330mm—8.0lt	Q07408
	410mm—13.0lt	Q07413
S/S Chinese (no stand) 18/8, Fine	280mm	I72427
S/S Chinese (no stand) 18/8, Coarse	280mm	I72428
S/S Chinese (no stand) 18/8, Fine	380mm	I72437
S/S Chinese (no stand) 18/8, Coarse	380mm	I72438
Aluminium, Heavy Duty	350mm—13.0lt	I61800

FRUIT STRAINER

Description	Dimensions	Code
Two parts, freezer proof—Thermo Hauser	335 x 105 x 80mm 345g	Q31090

UTENSIL RACK

Description	Dimensions	Code
Stainless Steel Utensil Rack—6 hook	400mm	Q32500



KITCHEN UTENSILS

PORTIONER SCOOPS

Description	Dimensions	Code	
Ice-Cream Scoop - Stainless Steel	No. 10	Q21110	
	No. 12	Q21112	
	No. 16	Q21116	
	No. 30	Q21130	
	No. 40	Q21140	
	No. 60	Q21160	
	No. 70	Q21170	
	No. 100	Q21200	
	Bonzer Lite-Grip Portioner	No. 6 (Biggest)	Q21506
		No. 8	Q21508
No. 10		Q21510	
No. 12		Q21512	
No. 14		Q21514	
No. 16		Q21516	
No. 24		Q21524	
No. 30		Q21530	
No. 40		Q21540	
No. 70 (Smallest)		Q21570	
Ice Cream Dipper—Regular	No. 12	Q21212	
	No. 20	Q21220	
	No. 24	Q21224	
Ice Cream Dipper - Non stick	No. 12	Q21412	
	No. 16	Q21416	
	No. 20	Q21420	
	No. 24	Q21424	
Natisco Heavy Duty S/S Ice-Cream Scoop - Stainless Steel	No. 4—100mm	1N004	
	No. 5—90mm	1N005	
	No. 6—82mm	1N006	
	No. 8—80mm	1N008	
	No. 10—70mm	1N0010	
	No. 12—67mm	1N0012	
	No. 16—59mm	1N0016	
	No. 24—51mm	1N0024	
	No. 36—47mm	1N0036	
	No. 60—40mm	1N0060	



Meat Tenderises

Description	Dimensions	Code
Meat Tenderiser—Aluminium	65 x 70mm 260mm long	Q03001
Extra Heavy Duty Meat Mallet Australian made		K1278



KITCHEN UTENSILS

HOOKS

Description	Dimensions	Code
Stainless Steel Hooks Available in 6 Different Sizes	80x4mm	QBH-012003
	100x4mm	QBH-012004
	120x5mm	QBH-012006
	140x5mm	QBH-012007
	160x6mm	QBH-012009
	180x8mm	QBH-012012



CHEQUE/MEMO HOLDER

Description	Dimensions	Code
Non-Clip S/S	450mm	Q05180
	750mm	Q05185
	1100mm	Q05190



POTATO PREPARATION

Description	Dimensions	Code
French Fry Cutter <ul style="list-style-type: none"> • Heavy Duty Cast Body • Cast Iron Handle • S/S trough • Wall or bench mounted • Brass bearings Available with 3 different size cutting frames:	330x200mm (overall)	Q03368 Q03364 Q03362
	7mm	
	10mm	
	13mm	
Cutting Frames also sold separately Interchangeable frame & block	7mm 10mm 13mm	Q03368-FB Q03364-FB Q03362-FB
Potato Ricer S/S Available in 2 Sizes	300mm 400mm	Q03346 Q03342
Potato Press S/S 18/10	270mm	Q03343
Potato Masher	80x80x265mm	Q32712
Heavy duty potato masher S/S	240x645mm	Q02235



Q03362

Q03362-FB



Q03342



Q03343



Q02235

EGG RINGS

Description	Dimensions	Code
Egg Ring S/S with handle	25x100mm	I30184
Egg Ring Non-Stick (set of 3)	15x75mm	3A3523
Egg Ring Aluminium (set of 3)	15x75mm	3A3521
Egg Ring Non-Stick "Heart shape" (set of 3)	15x80mm	3A3524



I30184

Q32712



3A3524



3A3523

KITCHEN UTENSILS

CUTLERY HOLDER		
Description	Dimensions	Code
Gastronorm standard Available in: white, grey & black	550x330mm	Q03641
S/S 4 Cylinder Holder Long	500x200mm	Q05243
S/S 4 Cylinder Holder 2x2	310x255mm	Q05244
S/S 6 Cylinder Holder	380x290mm	Q05245
Cylinder Single PE—White	90mm dia	Q05255
Cylinder Single S/S	90mm dia	Q05250



Q05243



Q03641



Q05245



Q05250



Q05244

KITCHEN UTENSILS

VEGETABLE PEELERS

Description	Dimensions	Code
Swivel Peeler S/S	115mm	3A9701a
Carbon Steel Blade	140mm	3D6080
Deluxe Peeler	160mm	3D6086



POULTRY LIFTER

Description	Code
S/S Poultry Lifter	3A3543



PASTRY / UTENSILS

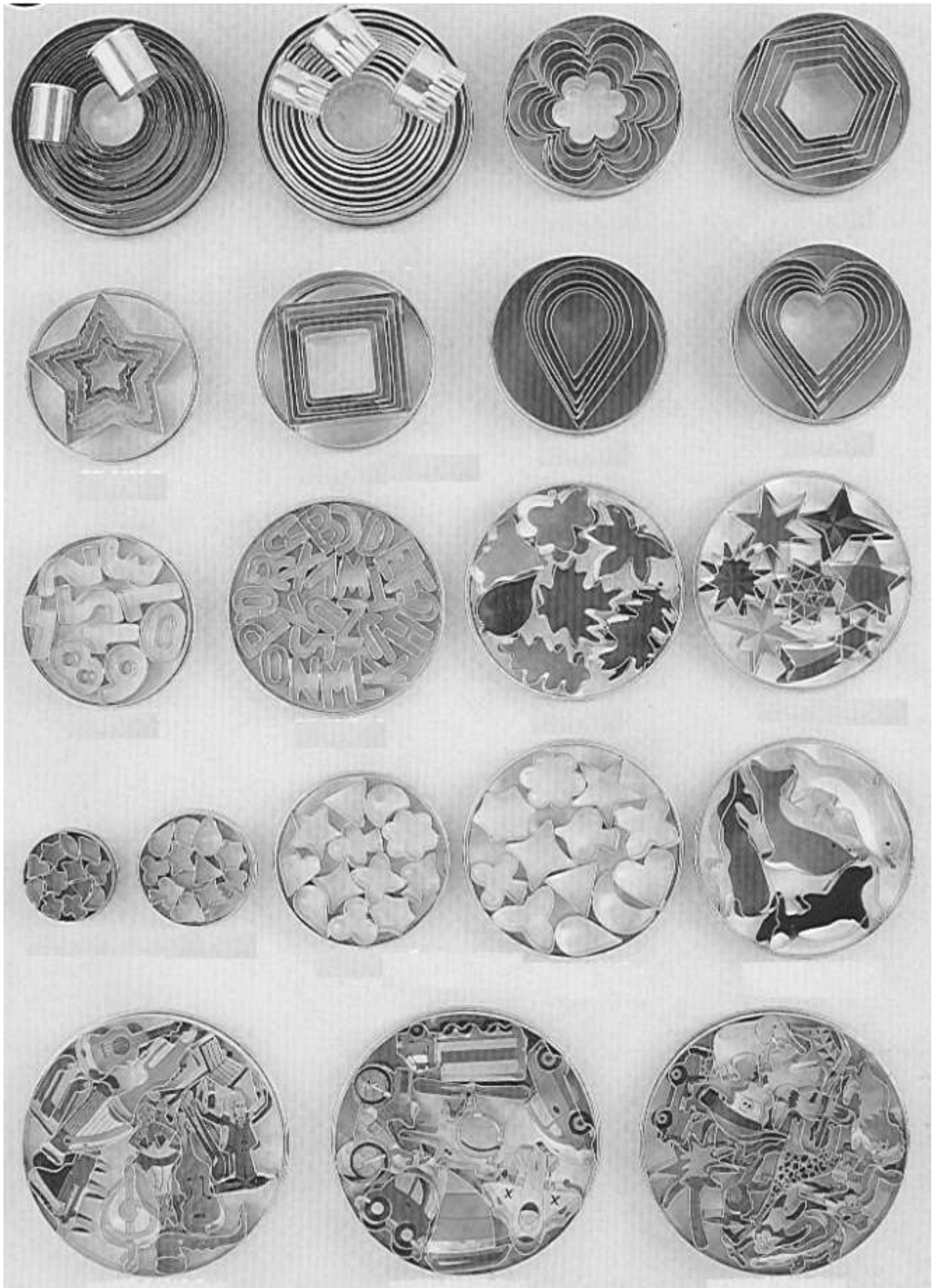

PASTRY / UTENSILS

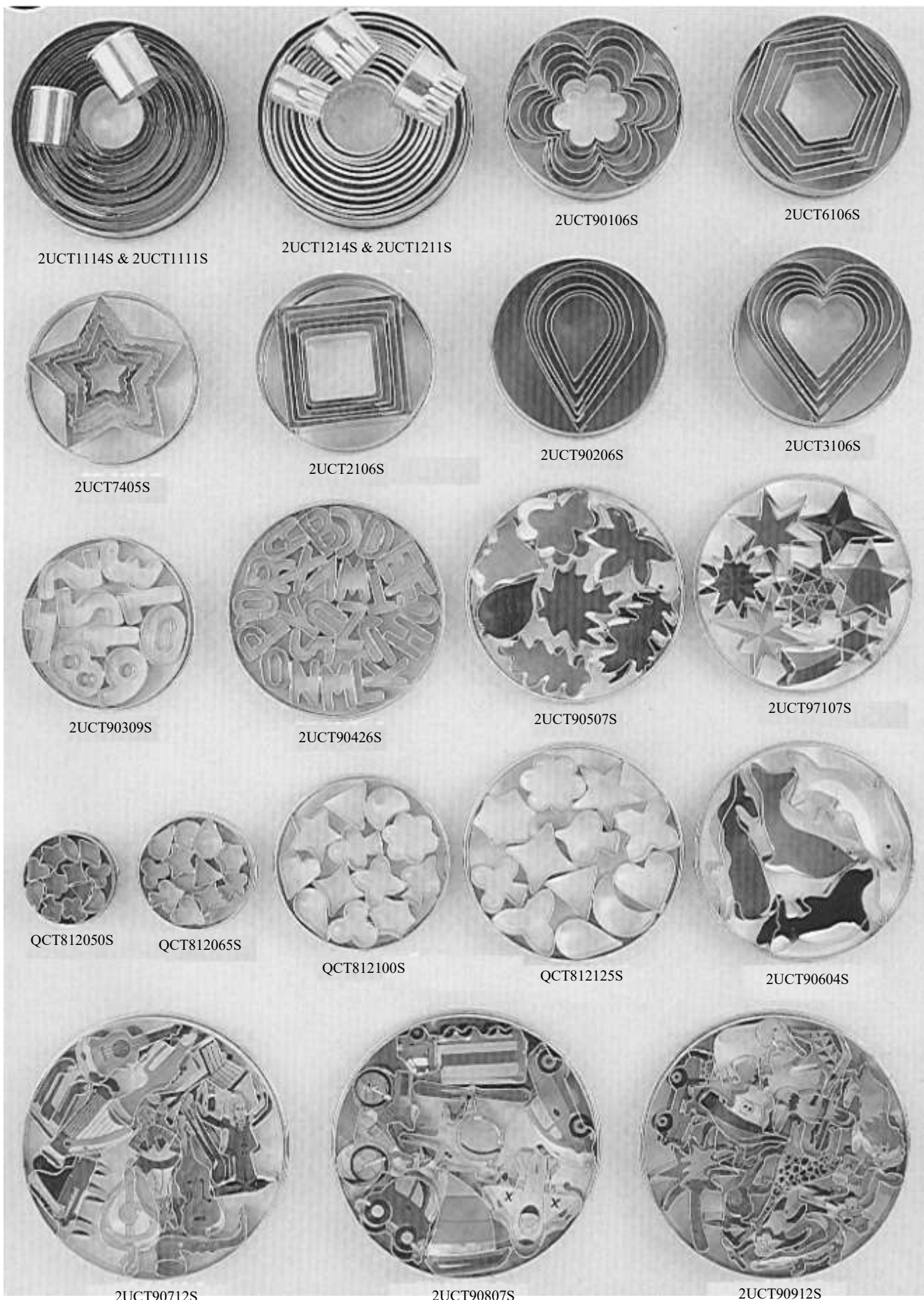

PASTRY UTENSILS

COOKIE CUTTERS—Thermo

Description	Dimensions		Code
	Height	Weight	
Shapes: stag, oval, horse, pig, fish, shapes for easter & Xmas-23 pieces	20-30mm	500g	Q31101
Shapes: animals, heart, star, X-mas tree, and clovers - 14 pieces	10mm	100g	Q31100



COOKIE CUTTERS—Sets of Shapes

Description	Dimensions (mm)		Code
	Sizes	Height	
Round set Plain - 3 piece			1F99134
Plain Round - Set of 14			2UCT1114S
Plain Round - Set of 11	22mm to 112mm	30mm	2UCT1111S
Scalloped Round - Set of 14	22mm to 90mm	30mm	2UCT1214S
Scalloped Round - Set of 11	22mm to 102mm	30mm	2UCT1211S
Plain Square - Set of 6	22mm to 85mm	30mm	2UCT2106S
Plain Hexagon - Set of 6	35mm to 70mm	30mm	2UCT6106S
Plain Petal - Set of 6	45mm to 95mm	30mm	2UCT90106S
Plain Teardrop - Set of 6	40mm to 95mm	30mm	2UCT90206S
Shape set- 6 pc Stainless Steel (<i>flower, 4 pt star, 5 pt star, heart, crescent, mushroom</i>)	50mm to 95mm	30mm	3A3216
Star set - 6 piece	45 - 90mm		Q01905
Star set Plain - 4 piece	35 - 85mm		3A2704
Shape set - 4 piece (<i>circle, flower, star, heart</i>)			3A2748
Plain Heart - Set of 6	45mm to 90mm		2UCT3106S
Plain & Scalloped Star - Set of 5	25mm to 90mm		2UCT7405S
Snowflake Set - 5 Piece			2UCT70829



COOKIE CUTTERS—Sets

Description	Dimensions	Code
Number Cutter Set - 9 pieces	35mm	Q019022U
Aspic Cutter Set - 12 pieces	15mm or 30mm	Q01946
Numbers - Set of 9	35mm x 20mm	2UCT90309S
Alphabet - Set of 26	25mm x 20mm	2UCT90426S
Autumn Leaves - Set of 7	Ht 20mm	2UCT90507S
Fish - Set of 4	Ht 20mm	2UCT90604S
Playful Cards Set - 4 piece		1C23041512
Music Time Set -12 piece	Ht 20mm	2UCT90712S
Transport - Set of 7	Ht 20mm	2UCT90807S
Zoo - Set of 12	Ht 20mm	2UCT90912S
Animal set - 10 piece		I51005
Gingerbread family set (2 boy, 2 girl)	50 - 125mm	1B02M0512
Gingerbread Cutter 3D	22 - 120mm	3A4834
Xmas Set - 4 pc (<i>santa, Xmas tree, reindeer, boy wearing santa hat</i>)		1C23040801
Xmas Set - 6 piece (<i>star, tree, candy cane, stocking, snowman, shooting star</i>)		3A3218
Xmas Set - 7 piece		3A2764
Xmas set - 9 on a Ring (<i>bell, wiseman, tree shooting star, dove, moon mushroom, star, flower</i>)		1F3070
Six Sided Cutter (<i>spade, cross, clover, square, diamond, heart</i>)		3A3235
Canapé Cutter - 9 pc Set		IF4122



3A4834



PASTRY UTENSILS



1E18 00

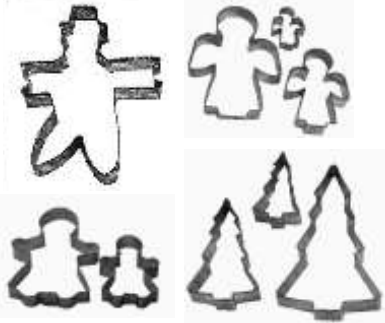

3A2716 3A2717



3A2747



2UCT199570

COOKIE CUTTERS—Assorted

Description	Dimensions	Code
Australiana Australia Map Emu Flag Kangaroo Koala Crocodile	100mm high x 80 long 95mm high x 80 long 70mm across x 95 pole 75mm high x 120 long 90mm high x 75 long 75mm	1E18-004 1E18-003 1E18-005 1E18-001 1E18-002 X3460
Shapes (single cutters) Heart Cutter Triangle Cutter Oval Cutter	75mm	2UCS3295 2UCS5110 X3457
Special Occasions Angel Star Plain Star Plain Christmas Tree Christmas Tree Holly Leaf Small	75mm 60mm 70mm 70mm 125mm 30mm	X3315 3A2731 3A2732 3A2734 3A2721 3A2730
Heart Heart set - 6 piece Heart set - 6 piece Giant Heart	50 - 90mm 25 - 100mm 200mm	Q01904 1C23040115 1C23030100
Bunny Sitting Standing		3A2716 3A2717
Alphabet & Number Cookie Cutters Cutter Set Aspic - 12 piece Cutter Set Aspic - 12 piece	36 Piece "Tin"	3A2747 Q01948 Q01950
Clown Cutter	90 mm	Q00967-09
Easter Favourite set - 5 piece Easter Cutters set - 6 piece		1C23041519 3A2761
Number Cutters: S/S Set of 9 pieces	100 x 30 mm	2UCT199570

PASTRY UTENSILS

COOKIE CUTTERS—Assorted

Description	Dimensions	Code
A		
Angel—mini	75mm	X1533
Apple S/S		X3466
Airplane - mini		X1573
B		
Bell - mini	75mm	X1511
Bell S/S		X3318
Boy - mini		X1505
Boy	50mm	X3305
Boy	75mm	X33655
Boy	125mm	3A2719
Brontosaurus—mini	90mm	X1644
Butterfly S/S		1C23081015
C		
Cat - mini	75mm	X2482
Cat S/S		X3336
Chick - mini		X1611
Cow - mini	75mm	X1526
Cow S/S		X3457
D		
Dog - mini	75mm	X2475
Dog S/S		X3464
Doughnut Cutter S/S		I51060
Duck (S/S)	75mm	X3311
Duck (plastic)	85 x 75mm	1C230301488
E		
Elephant - mini	75mm	X1521
Elephant S/S		X3339
F	75mm	X3469
Flower S/S	75mm	X3364
Feet S/S		
G		
Ghost - mini	75mm	X1597
Giraffe S/S		X3405
Girl		X3304
Goose - mini	125mm	X1509
H		
Half-moon - mini	75mm	X1597
Half-moon S/S		X3337
Hand S/S	75mm	X3465
Horse S/S	75mm	X3471
House S/S	75mm	X3347
I—L		
Locomotive S/S	75mm	X3334
M—N		
Mamma Bear	100mm	X3443
O-P		
Pig - mini	75mm	X1527
Pig S/S		X3341
Q—R		
Rabbit - mini	75mm	X1613
Rabbit S/S		X3307
Rocking Horse - mini		X1534
S		
School Bus S/S	75mm	X3299
T—Z		
Tea Pot S/S	75mm	X3468
Teddy Bear - mini	50mm	X1540
Teddy Bear		X33544
Teddy Bear S/S	75mm	X3354
Teddy Bear (giant)	200mm	1C23030098
Train - mini	75mm	X1573
Tree S/S		X3308
Turkey - mini		X1550



PASTRY UTENSILS



PASTRY UTENSILS

COOKIE CUTTERS—S/S		
Description	Dimensions	Code
Heart - Plain	50mm	2UCS3150
Scalloped	50mm	2UCS3250
Plain	65mm	2UCS3165
Scalloped	65mm	2UCS3265
Plain	80mm	2UCS3180
Scalloped	80mm	2UCS3280
Plain	95mm	2UCS3195
Scalloped	95mm	2UCS3295
Plain	110mm	2UCS31110
Scalloped	110mm	2UCS32110
Round no Handle - Large Scalloped	100mm 120mm	2UCS13100 2UCS13120
Square no Handle Plain	50mm 75mm	2UCS13100 2UCS13120
Square with Handle - Plain	100mm 125mm	2UCS21100H 2UCS21125H
Triangle no Handle - Plain	60mm x 70mm 100mm x 110mm	2UCS5170 2UCS51110
Dinosaur Cutter Set of 6		1B02MO547
Valentine Cutter Set of 7		1B02MO548
<u>Doughnut Cutters</u>		
S/S Heavy duty cutter	80 x 40 x 14 mm	2U155011
- S/S Cutter	63 mm	Q01442/6
- S/S Cutter	90 mm	Q01442/9
- S/S Rectangular	75 x 35 mm	1R150322
- S/S Rectangular	80 x 40 mm	1R150323
Plain Biscuit Cutters S/S	38 mm 63 mm 90 mm 110 mm	Q01440/4 Q01440/6 Q01440/7 Q01440/10
Crinkled Biscuit Cutters S/S	38 mm 63 mm 90 mm 110 mm	Q01441/5 Q01441/6 Q01441/7 Q01441/10

See previous page for pictures of Cookie Cutters



2U155011



Q01442 / 6



Q01440/4



Q01441/5



1B02MO548



1B02MO547

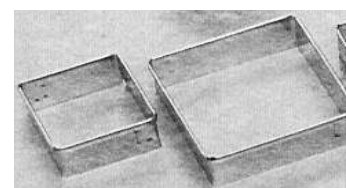

1R150322

PASTRY UTENSILS



1R150101 - 1R150104



1R150201



1R150215

COOKIE CUTTERS—Exoglass

Description	Dimensions	Code
Exoglass withstands heat up to 160°C		
Boxed set :		
9 round fluted	20 - 100mm	1R150101
7 round fluted	35 - 95mm	1R150102
8 round plain	30 - 100mm	1R150103
7 round plain	35 - 95mm	1R150104
Boxed set - 7 oval fluted	40 - 130mm	1R150201
Exoglass Cutter Heart	47 x 44mm	1R150215

PASTRY UTENSILS

PASTRY CUTTERS—Bar Handle

Description	Dimensions	Code
Fluted Cutter Bar Handle S/S	140mm	P06CF5.5BH
	150mm	P06CF6BH
	160mm	P06CF6.5BH
	175mm	P06CF7BH
	190mm	P06CF7.5BH
	205mm	P06CF8BH
	215mm	P06CF8.5BH
	225mm	P06CF9BH
	240mm	P06CF9.5BH
	255mm	P06CF10BH
Plain Cutter Bar Handle S/S	140mm	P06CP5.5BH
	150mm	P06CP6BH
	160mm	P06CP6.5BH
	175mm	P06CP7BH
	190mm	P06CP7.5BH
	205mm	P06CP8BH
	215mm	P06CP8.5BH
	225mm	P06CP9BH
	240mm	P06CP9.5BH
	255mm	P06CP10BH



PASTRY CUTTERS—Block Top

Description	Dimensions	Code
Fluted Block Top Chrome Plated	50mm	P06CF2BT
	63mm	P06CF2.5BT
	76mm	P06CF3BT
	89mm	P06CF3.5BT
	100mm	P06CF4BT
	113mm	P06CF4.5
	127mm	P06CF5BT
Plain Block Top Chrome Plated	25mm	P06CP1BT
	38mm	P06CP1.5BT
	51mm	P06CP2BT
	63mm	P06CP2.5BT
	89mm	P06CP3.5BT
	100mm	P06CP4BT
	113mm	P06CP4.5BT
	127mm	P06CP5BT

2ULP34253



1R141106

PASTRY CUTTERS—Lattice

Description	Dimensions	Code
Lattice Matrix - 2 piece - White	300mm	Q31025
Lattice Cutter	115mm	2ULP5305
Lattice Cutter - Thermo	120mm	2ULP34253
Lattice Cutter - Thermo S/S	125mm	1R141106
Blades also available		

Q31923



CUTTING ROLLER

Description	Dimensions	Code
Bear Claw Cutting Roller (Thermo Hauser)	Width: 60mm Weight: 60g	2U34073



PASTRY UTENSILS

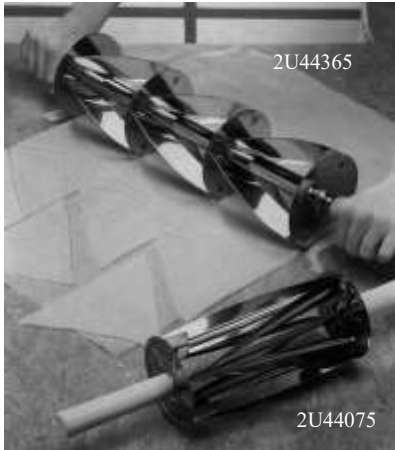

CROISSANT CUTTERS

Description	Dimensions	Code
Triangular Cutter Thermo Hauser	1 section 2 sections 3 sections	2U44075 2U44365

DOUGH DIVIDERS

Description	Dimensions	Code
Dough Divider Light duty style	5 wheel 6 wheel 7 wheel	Q01395 Q01396 Q01397
Heavy duty Matfer - made in France	5 wheel 7 wheel 5 wheel fluted	1R141010 1R141012 1R141013



DOUGH PRESSER

Description	Dimensions	Code
Dough Presser, set of 3, white	dia - 150, 120, 90mm	1NDS



ROLLER DOCKERS

Description	Dimensions	Code
Dough Docker S/S	125mm	Q01400
Plastic dough Docker	Width - 115mm	2ULP5104
Heavy duty Plastic (Thermo Hauser)	Width - 60mm Width - 115mm Width - 270mm	2ULP34083 2ULP34093 2ULP34233



Q01400



1NDS



PASTRY UTENSILS

CAKE MARKER/DIVIDER—Plastic

Description	Dimensions	Code
Double-Sided Loyal	8/12 265mm 12/16 265mm 12/18 14/16 14/18	2ULP35295 2ULP35305 2ULP35135 2ULP35125 2ULP35145
Single-Sided Loyal	8 265mm 10 12 14 16 18	2ULP35055 2ULP35065 2ULP35075 2ULP35085 2ULP35095 2ULP35105
Rectangular Thermo Hauser Useable on both sides	440 x 235	Q31050

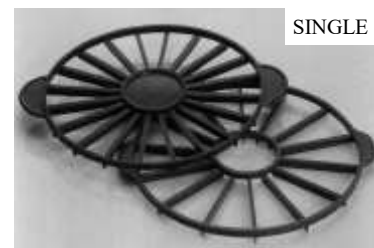

ROLLING PINS

Description	Dimensions	Code
Aluminium Heavy Duty	450mm 280 x 60mm 330 x 70mm 450 x 70mm 330 x 75mm 380 x 75mm 450 x 75mm	Q03667 Q03652 Q03653 Q03657 Q03660 Q03661 Q03662
Wood - H/D	400 x 70mm 450 x 70mm	2NPIN16 2NPIN18
Wood - Nickel Plated Fittings Thermo Hauser	450mm	Q31152
French Style - wood	510 x 50mm 550 x 50mm	Q03659 I51725
French Style - White Poly	500 x 48mm	1R140018
Poly	400 x 80mm 450 x 90mm	2U44931 2U44941
Rubber Coated	460 x 95mm	PRC457



Q31149

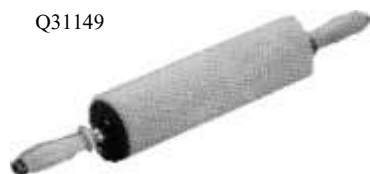

I51725



1R140018



2U44941



PRC457



PASTRY UTENSILS

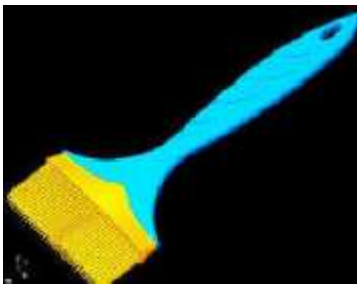
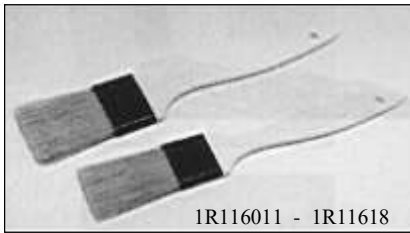

PASTRY BRUSHES

Description	Dimensions	Code
Plastic, flat handle - dishwasher proof, bristle	25mm	1R116011
	30mm	1R116012
	35mm	1R116013
	40mm	1R116014
	45mm	1R116015
	50mm	1R116016
	60mm	1R116017
	70mm	1R116018
Plastic, round handle—bristle	15mm	1R116020
Plastic, flat handle - 70x50mm white, bristle Also available in blue & Red	18cm	HFBK82125W
Plastic, flat handle - 50x50mm White 18cm Also available in blue & Red	18cm	HFBK81125W
Plastic handle brush cream colour	35mm	2ULP40235
	40mm	2ULP40240
	50mm	2ULP40250
	60mm	2ULP40260
	75mm	2ULP40275
Wooden handle pastry brush	40mm	1F5219
	50mm	1F99091
	75mm	Q31506
	100mm	Q31510
Plastic handle brush white, with hook	50mm	I69512
	75mm	I69513
Silicone Rubber Brushes Silicon Rubber brush with F.D.A standard	28mm	
	40mm	
	102mm	
Silicone Brush with steel handle BR-05 - with 59 tails	40mm	
BR-12 - with 77 tails	50mm	
BR-23 - with 99 tails	65mm	

PASTRY UTENSILS

BENCH SCRAPERS

Description	Dimensions	Code
Wood Handle	180 x 105mm	Q03027
Wood Handle S/S	150 x 75mm	Q03026
Plastic Handle	150 x 75mm	Q03056I
Flexible S/S	120 x 85mm 120 x 65mm	2ULS3612 2ULS3612S
Plastic Handle	120 x 180mm	P34BSA
Plastic Handle S/S	60 x 170mm 60 x 270mm	2ULP20700 2ULP20701



P34BSA



2ULP20700

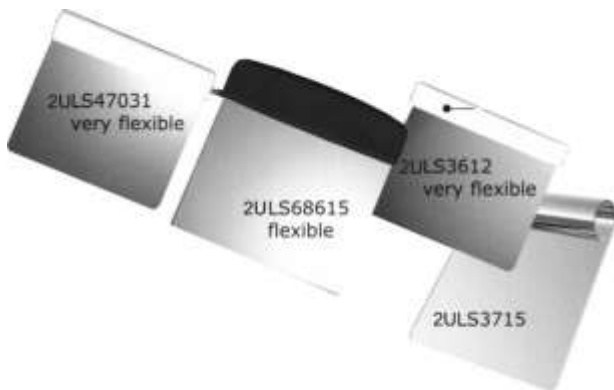

Q03056I



Q03026



2ULS3612S

SCRAPERS

Description	Dimensions	Code
S/S	100 x 210mm	Q03018
S/S P/H	78 x 230mm	Q03058



Q03058

Q03018

CAKE TESTER

Description	Dimensions	Code
Cake Tester	100mm	Q01444



PASTRY UTENSILS

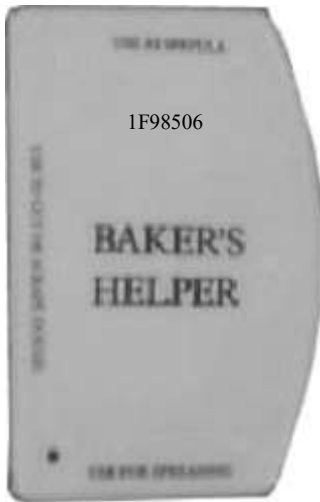

BOWL SCRAPERS/COMBS (part 1)		
Description	Dimensions	Code
Leveller (Thermo Hauser)	116 x 76mm—12g	Q31400
	121 x 81mm—12g	Q31401
	141 x 100mm—19g	Q31402
	113 x 75mm—10g	Q31410
	120 x 88mm—11g	Q31411
	115 x 95mm—11g	Q31412
Bowl Scraper (Thermo Hauser)	118 x 80mm—11g	Q31405
	160 x 120mm—25g	Q31409
	195 x 148mm—38g	Q31413
Cutting/Edge grip (Thermo Hauser) with comb with round edges	216 x 128mm—42g	Q31415
	216 x 128mm—42g	Q31416
	216 x 128mm—42g	Q31417
Comb scraper, double sided (Thermo Hauser)	110 x 75mm 9g	Q31420
Garnish scraper, round teeth (Thermo Hauser)	115 x 76mm 8g	Q31421
Comb scraper, triangular (Thermo Hauser)	93 x 83mm 5g	Q31423
Bakers Helper - very flexible (Thermo Hauser)	95 x 145mm	1F98506

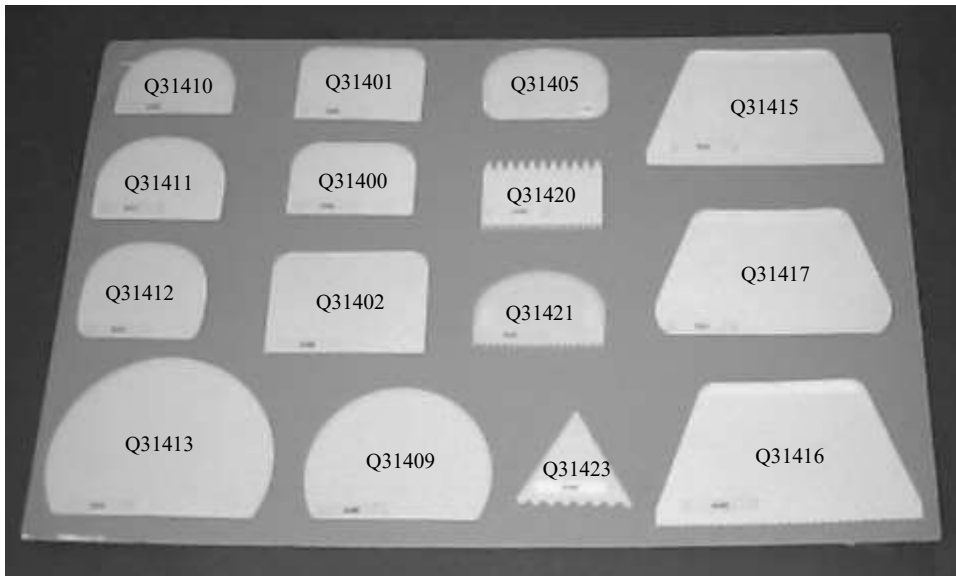

SERVING & DISPLAY

DISPLAY TRAYS - Stainless Steel

Description	Dimensions	Code
Octagonal Display Tray	260 x 200mm 400g	Q70327
	370 x 270mm 820g	Q70328
Oval Display Tray	360 x 250mm 740g	Q70350
	410 x 280mm 980g	Q70351
	460 x 310mm 1450g	Q70352
Rectangular	310 x 225mm	I76193
	345 x 245mm	I76194

Q70327



Q70350



I76194



SERVING TRAYS - Plastic - (Other colours available)

Description	Dimensions	Code
Black	250 x 350mm	Q06984-BK
Red	250 x 350mm	Q06984-R
White	250 x 350mm	Q06984-W
Rectangular Tray (various colours available)	390 x 150	I91040
Rectangular Tray (black or white)	390 x 150mm	I91040-B
White (Smooth finish)	350x270mm	I41373
	400x300mm	I41372
	450x330mm	I41371
	650 x400mm	I41370
Black	300 x 400mm	Q06985-BK
Red	300 x 400mm	Q06985-R
Black	350 x 450mm	Q06986-BK
Red	350 x 450mm	Q06986-R
White	350 x 450mm	Q06986-WH
White (20mm lip either end)	350 x 450mm	I49018-WH
Black (20mm lip either end)	350 x 450mm	I49018-BK
Multi Purpose Serving Tray	300 x 400mm	JAP8300
Deep Dish White Serving Tray	350x250x70mm	I91072-W
Round Tray white Serving Tray	12"/300mm	W20126
<i>(Other colors available on request)</i>		

Q06986-BK



I91032-W



I91040

I91040-B

I41373

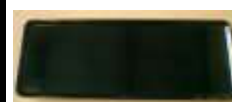

I91040-w



JAP8300



I91072-W



W20126

Cupcake and Cake Carrier

Description	Code
Collapsible Cupcake and Cake carrier	1F55020

1F55020



SERVING & DISPLAY

Stainless Steel

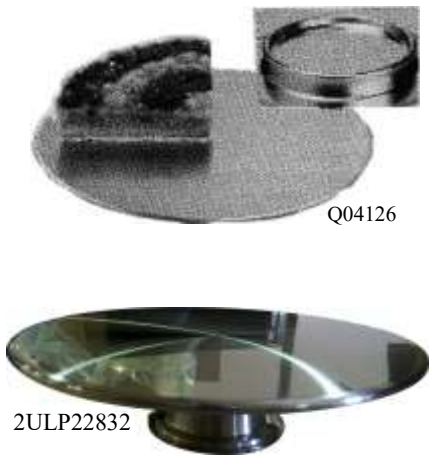

CAKE STANDS—Round

Description	Dimensions	Code
S/S Stand flat	Height- 25, Dia- 300mm	I74115
S/S Stand low	Height- 70, Dia - 300mm	I74120
S/S Stand high	Height- 185, Dia - 300mm	I74125
S/S Stands	Height - 35, Dia. - 315mm Height - 75, Dia. - 320mm	Q04126 2ULP22832
Cake Cover - Chrome Handled		Q04140
Cake Cover & Rack Complete		Q04150
Cake Cover - Break Resistant		VRD1200CW
Dome covers	Dia 300mm Dia 400mm	I74144 I80013

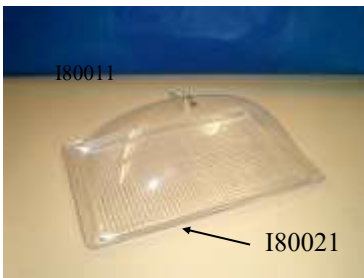
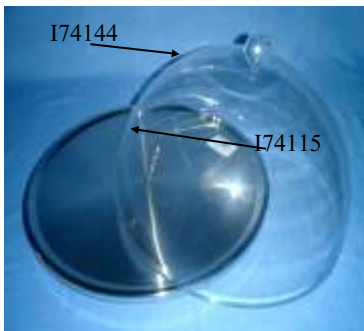

CAKE PLATES

Description	Dimensions	Code
Protection Cover (Thermo Hauser)	H: 110 x Dia: 300mm (290g)	Q31009
Plate (Thermo Hauser)	H: 25 Dia: 300mm (240g)	Q31012



SERVING & DISPLAYS

Description	Dimensions	Code
Square cover	350 x 350mm	I80010
Tray to suit square cover	350 x 350mm	I80020
Rect Cover	400x300mm	I80011
Tray to suit rect cover	400x300mm	I80021
Dome Cover & tray, hinged	550 x 350 x H: 185mm	I80060
Rect Cover & Tray, opens 2 ends	550 x 350 x H: 140mm	I80065
Display Cabinet with 2 removable trays	480 x 405 x H: 360mm	I80080
Replacement tray for display cabinet	470 x 330mm	I80082
Rect Display cover small	325 x 530mm	VRD1220CW
Rect Display cover large	670 x 480mm	VRD1826CW



SERVING & DISPLAY

TONGS

Description	Dimensions	Code
White - Polycarbonate (Plastic)	240mm	Q43060-W
Red- Polycarbonate (Plastic)	240mm	Q43060-R
Black - Polycarbonate (Plastic)	240mm	Q43060-BK
White - Polycarbonate (Plastic)	300mm	I43061-W
Utility Tong Heavy Duty S/S with lock	240mm	Q03060
Utility Tong H/D S/S	240mm	Q03064-C
Utility Tong H/D S/S with lock	300mm	Q36062
Utility Tong H/D	250mm	Q36060
Pastry Tong Stainless Steel - 1 piece	240mm	I30092
Food Tong Stainless Steel - 1 piece	230mm	IA3299
Cake Tong H/D S/S - 1 piece	185mm	Q70201
Rubber Grip Handle S/S Tong	200mm	3A3304
Rubber Grip Handle S/S Tong	300mm	3A3305
Mini Tong S/S CDU/24	180mm	IF98658
Spoon & Fork Tong S/S	200mm	Q03079
Salad -Spaghetti Tong S/S	230mm	3D13822
Coloured Food Tong/Plastic Handle Available in White, Green, Brown, Red, Black, Blue	230mm	I48009-W
S/S Claw Tong-Scissor action	280mm	3D13654

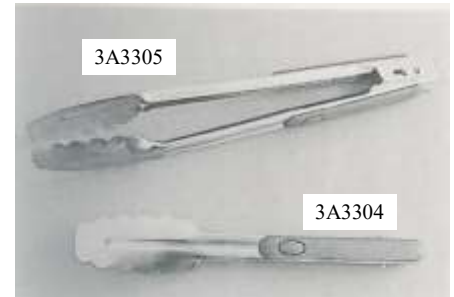

PASTRY SERVERS		
Description	Dimensions	Code
S/S - Plastic Handle	110mm blade	Q03054
S/S - Wood Handle - Professional	110mm blade	Q03024



CAP-GRIPPER		
Description	Dimensions	Code
Cap-Gripper—Help weak Hands	195 mm	3A3443

SERVING & DISPLAY

PLASTIC FOOD/DISPLAY

Description	Dimensions	Code
Wide Range Available to order		3A5753



BREAD BASKET/TRAY

Description	Dimensions	Code
Bread Basket Bamboo (Oval)	190 x 250mm	I41810
Bread Tray Polypropylene (Rectangle) (Dishwasher Safe)	160 x 365mm 280 x 410mm 310 x 5 60mm	Q4556 Q4573 Q4575
Heavy Duty Baskets Polypropylene (Round) (Dishwasher Safe)	210 x 90mm 230 x 90mm 260 x 90mm	I41708 I41709 I41710
Heavy Duty Baskets Polypropylene (Oval) (Dishwasher Safe)	240 x 170mm 280 x 170mm 380 x 270 x 90mm	I41729 I41730 I41750
Heavy Duty Baskets Polypropylene (Rectangular) (Dishwasher Safe)	450 x 310 x 60mm 360 x 270 x 90mm 530 x 320 x 90mm	I41755 I41760 I41765
Stand for 2 Baskets		I41762

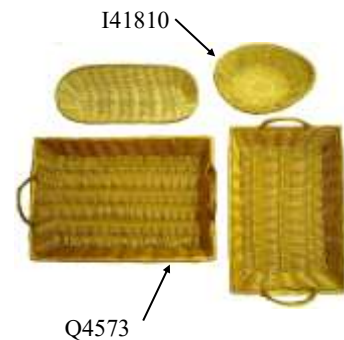

I41708



I41729



I41750



I41760

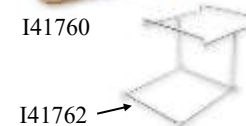

I41762



I41755

FOOD COVER

Description	Dimensions	Code
No Fly Zone Food cover	970x970mm	3A3295



DECORATING UTENSILS & EQUIPMENT



Q31001



3A2819

DECORATING/CAKE STANDS		
Description	Dimensions	Code
Revolving Cake Stand	315 x 85mm 315 x 11mm 275 x 75mm	Q31000 Q31001 3A2819
S/S HD Cake Stand Revolving	300 x 50mm	Q00615
Turntable cake stand (2pc)	300mm x 115mm	I51812



I51812



Q31000



Q00615



1F4701

MARBLE REVOLVING PLATTER		
Description	Dimensions	Code
A perfect revolving entertaining platter, great for cheese, condiments, fruit & more...	30cm diameter	3A4710



DECORATING UTENSILS & EQUIPMENT

DESSERT DECORATOR

Description	Dimensions	Code
Icing Syringe S/S with 5 nozzles	190 mm	1F4463
Cake Decorator Pro + 5 nozzles	280mm	1F4463



COOKIE PRESS/ICING SET

Description	Dimensions	Code
Mondo Professional: Biscuit Maker Complete with Cookie Discs & Decorating Tips	200mm	1B01MO762



SUGAR BLOW TORCH

Description	Dimensions	Code
Sugar Blow Torch Refillable	155x80mm	1R262266
Sugar Blow Torch gas replace Cart C206	150x200mm	1R262268



PIPING BAGS

Description	Dimensions	Code
Fine Line (Loyal)	205mm/8"	2ULB2008
	255mm/10"	2ULB2010
	305mm/12"	2ULB2012
	355mm/14"	2ULB2014
	405mm/16"	2ULB2016
	455mm/18"	2ULB2018
	510mm/20"	2ULB2020
Loyal - Standard	280mm	2U14010
	340mm	2U14020
	400mm	2U14030
	460mm	2U14040
	500mm	2U14050
	550mm	2U14060
	600mm	2U14070
Loyal - Heavy Duty	280mm	2U13010
	340mm	2U13020
	400mm	2U13030
	460mm	2U13040
	500mm	2U13050
	550mm	2U13060
	600mm	2U13070
Disposable Bags (Loyal)	305mm/12"	2ULB2412
	455mm/18"	2ULB2418
	550mm/22"	2ULB2422
Pastry bag Holder	230mm	1R169001



DECORATING UTENSILS & EQUIPMENT

WALL RACKS

Description	Dimensions	Code
For Pastry Bags & Piping Tips (Thermo Hauser)	500 x 500mm—1300g	Q31097



SHAKERS

Description	Dimensions	Code
White Plastic Shaker		1F98569
Plastic with S/S Mesh Top		1F4646
S/S Shaker	285ml 35ltr 50ltr	Q07242 Q07251 Q07252
S/S Flour/Sugar	285ml	3A4963
S/S Salt Dredge	285ml	Q07241
S/S Salt Dredge W / handle	285ml	I70111
S/S Salt Dredge	450ml	Q07243
S/S Salt Dredge W/ handle	500ml	I70121
Sugar Dispenser -Glass, S/S top	335ml	Q06755
Cheese - Glass, S/S top	335ml	Q06800
Plastic with S/S Top, Colours available In white, yellow, blue, red & black	185ml	
S/S Shaker 3 in 1	200ml	X42083
S/S Salt & Pepper Shaker Set of 2	50ml	I70067
Mesh Cocoa / Cinnamon Small Fine	50ml	3A4362-1



CREAM WHIPPER

Description	Dimensions	Code
Cream Gun Whipper	0.5ltr 1ltr	2ICGB0001 2ICGB0002
Cream Charges Pkt 10		2ICGB1001



FLOWER NAILS—Metal

Description	Dimensions	Code
No 7 Flower Nail	30mm	1C04023007
No 9 Flower Nail	40mm	1C04023007



TUBE SETS/COUPLING

Description	Dimensions	Code
Coupling	Delrin coupling for all standard decorating tubes	QDC-2
Large Tip Coupler	65mm	1C04111006
Tube Cleaning Brush	100mm	Q31560
Decorating Tube Set (26 piece)		Q00782
Decorating Tube Set (52 piece)		Q00783
26 Piece tip Saver Box	26 pieces	1C04058773
52 Piece tip Saver Box	52 pieces	1C04057777



DECORATING UTENSILS & EQUIPMENT

Decorating Tips *All tips work with standard bags and couplers, unless otherwise indicated.*

Round Tips

Outline, lettering, dots, balls, beads, stringwork, lattice, lacework.

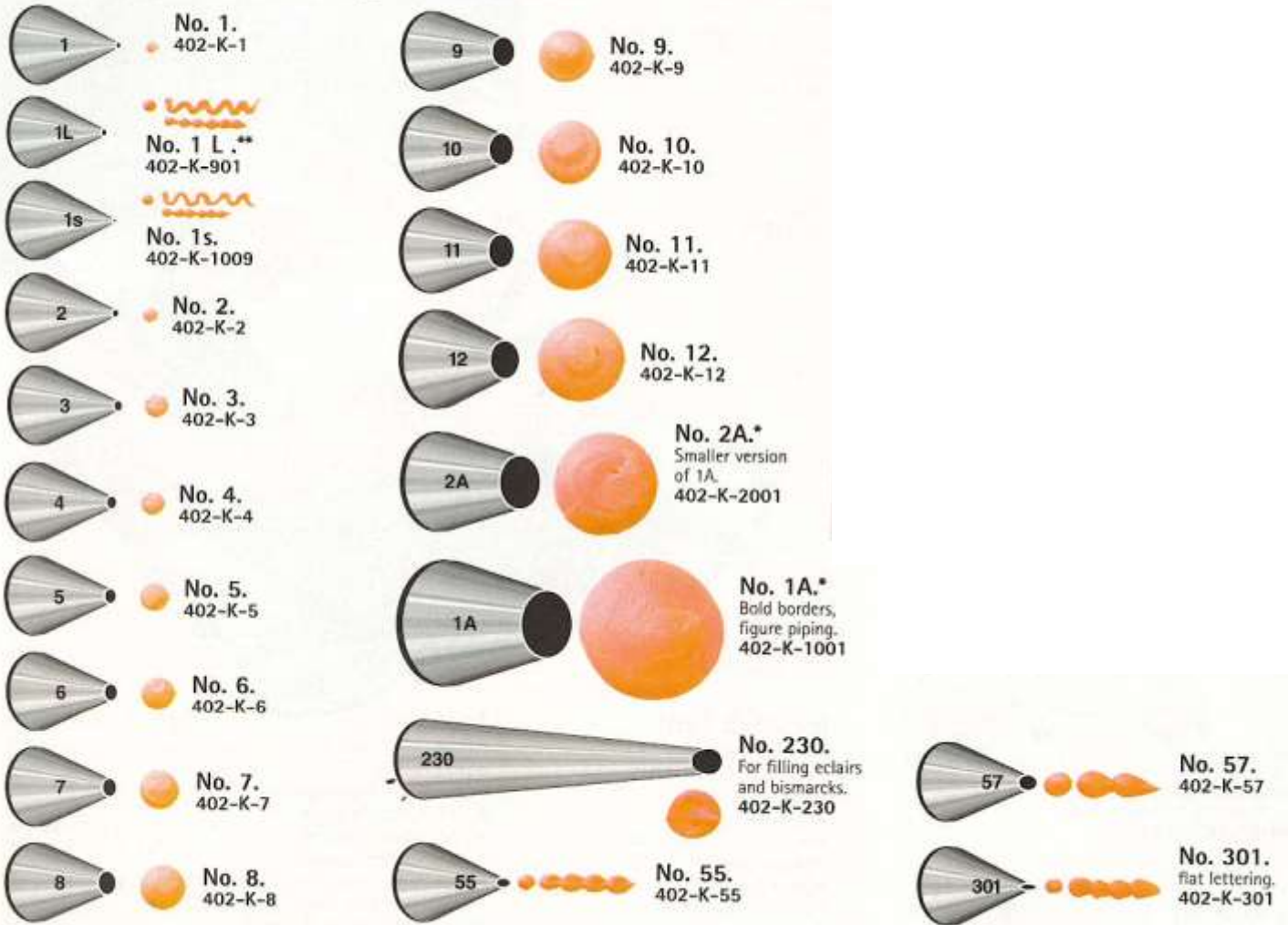

Closed Star Tips

Create deeply grooved shells, stars and fleurs-de-lis.

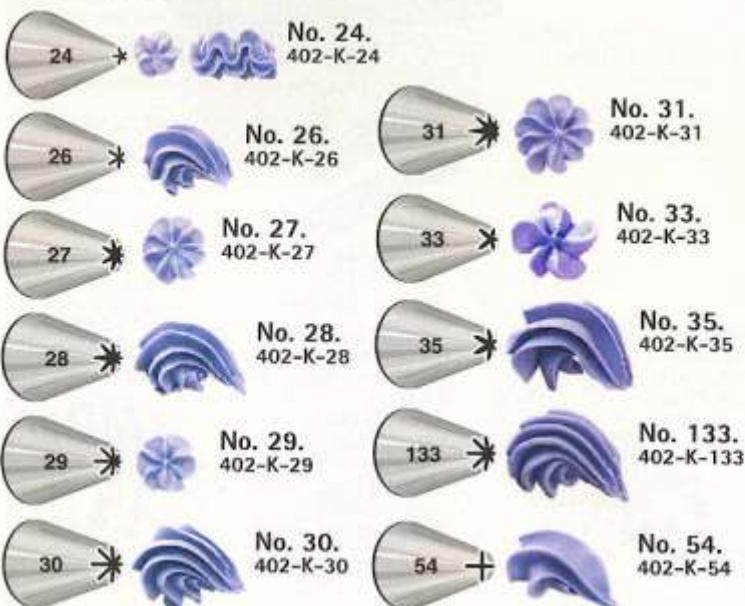

Multi-Opening Tips

Rows and clusters of strings, beads, stars, scallops.

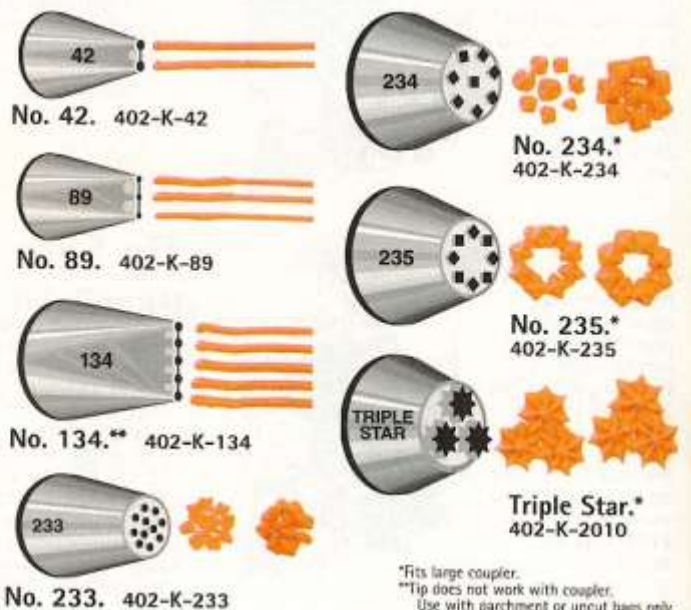

*Fits large coupler.
**Tip does not work with coupler.
Use with parchment or uncut bags only.

DECORATING UTENSILS & EQUIPMENT

Open Star Tips

Star techniques and drop flowers; the finely cut teeth of 199 thru 364 create decorations with many ridges; use 6B and 8B with pastry dough too.

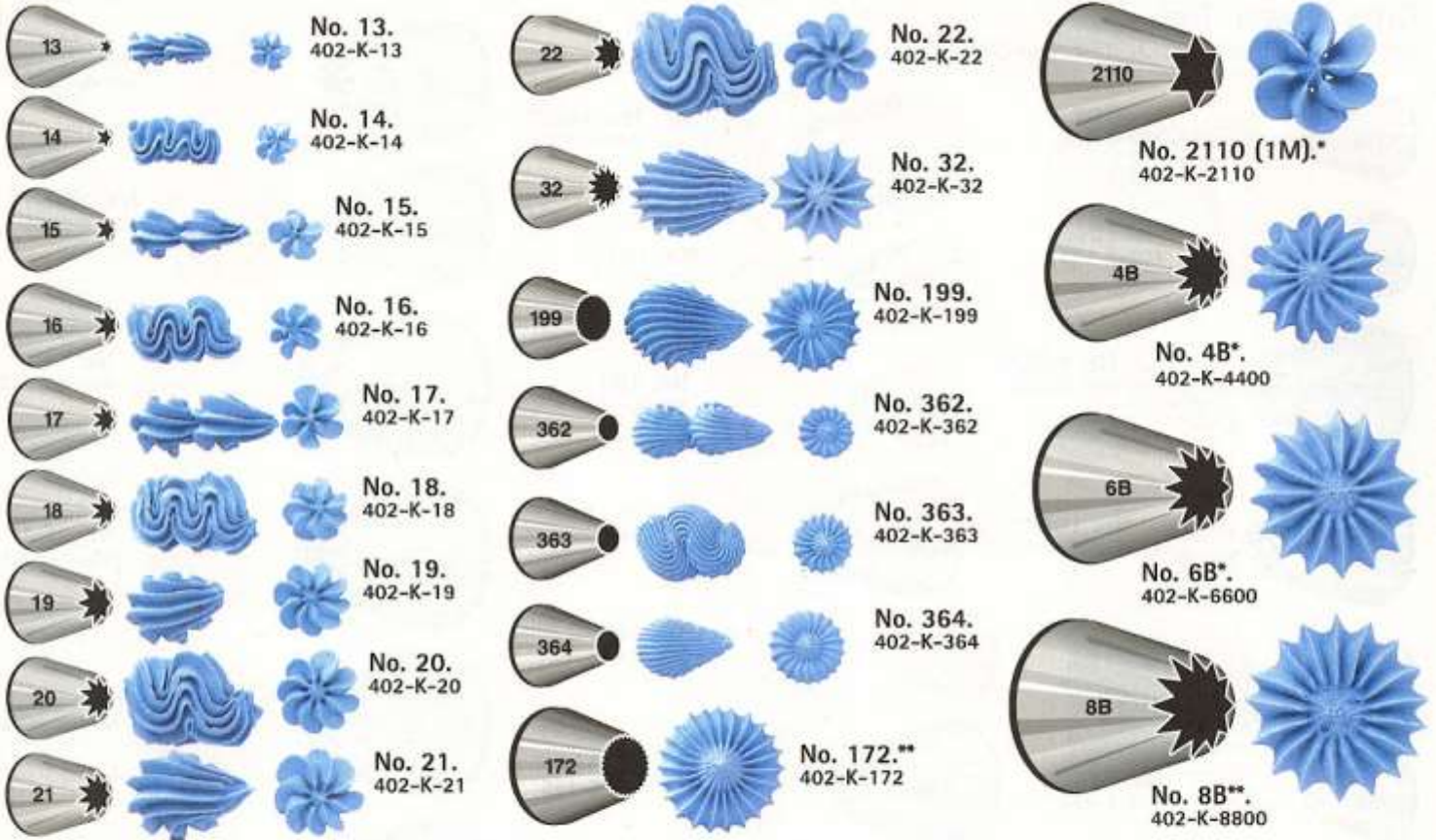

Leaf Tips

So realistic! Ideal for shell-motion borders too.

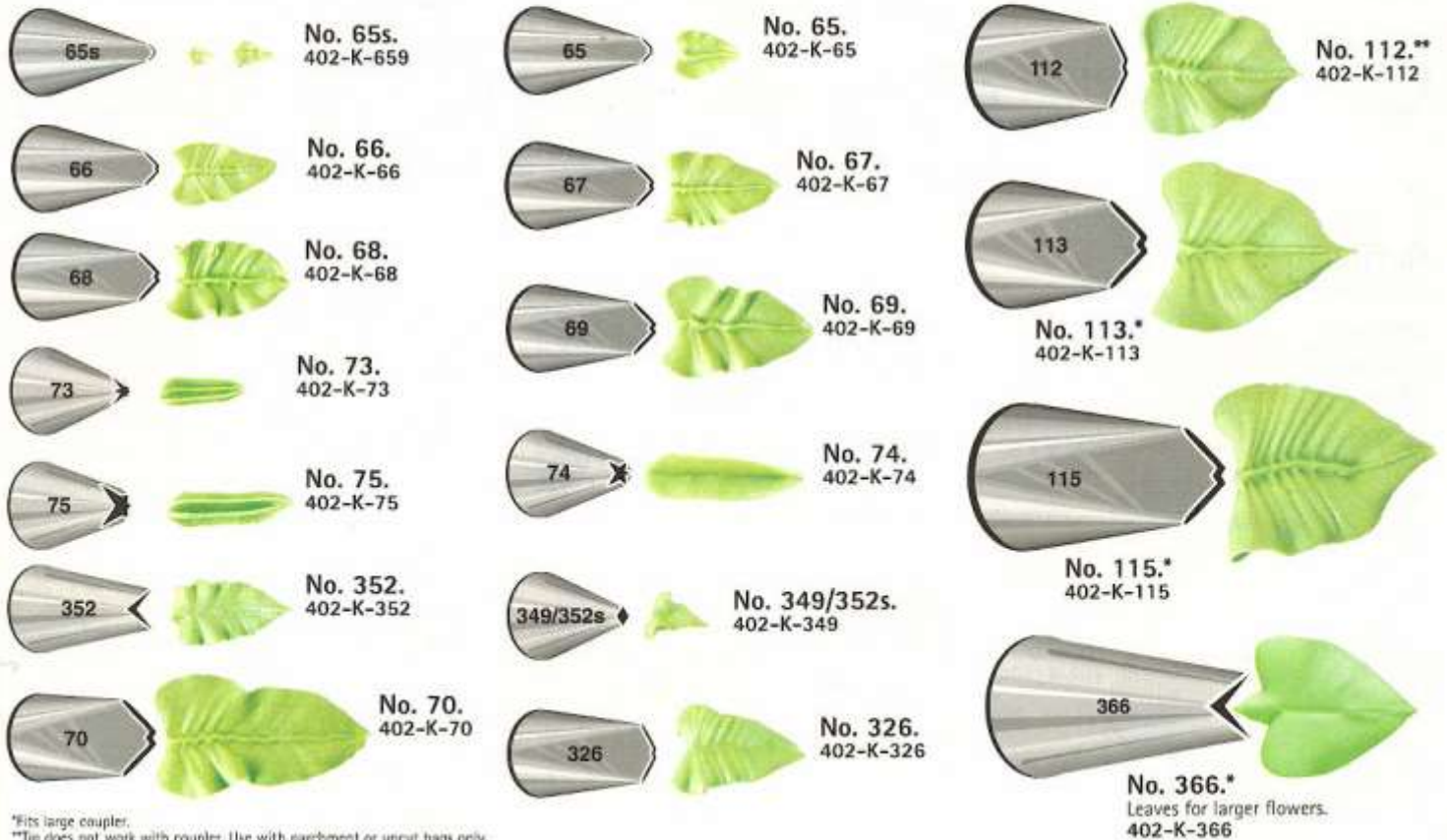

*Fits large coupler.















































**Tip does not work with coupler. Use with parchment or uncut bags only.

DECORATING UTENSILS & EQUIPMENT

Decorating Tips All tips work with standard bags and couplers, unless otherwise indicated.





















Drop Flower Tips

Small (106-225); medium (131-194); large (2C-1G) great for cookie dough too.

		No. 106. 402-K-106			No. 190.** 402-K-190			No. 2E.* 402-K-2005
		No. 107. 402-K-107			No. 191. 402-K-191			No. 2F.* 402-K-2006
		No. 108.** 402-K-108			No. 193. 402-K-193			No. 1B.* 402-K-1002
		No. 109.** 402-K-109			No. 194.** 402-K-194			No. 1C.* 402-K-1003
		No. 129. 402-K-129			No. 140. 402-K-140			No. 1E.* 402-K-1005
		No. 224. 402-K-224			No. 195.** 402-K-195			No. 1F.* 402-K-1006
		No. 225. 402-K-225			No. 2C.* 402-K-2003			No. 1G.* 402-K-1007
		No. 131. 402-K-131			No. 2D.* 402-K-2004			

Ruffle Tips

Plain, fluted, shell-border, special effects.

		No. 86. 402-K-86			No. 340. 402-K-340			
		No. 87.† 402-K-87			No. 401. 402-K-401			
		No. 88.† 402-K-88			No. 402.* 402-K-402			
		No. 100. 402-K-100						
		No. 353. 402-K-353						

†For left-handed people.
*Fits large coupler.
**Tip does not work with coupler. Use with parchment or uncut bags only.

DECORATING UTENSILS & EQUIPMENT

Petal Tips

Realistic flower petals, dramatic ruffles, drapes, swags and bows.



No. 59s/59°. 402-K-594



No. 59. 402-K-59



No. 60. 402-K-60



No. 61. 402-K-61



No. 62. 402-K-62



No. 64. 402-K-64



No. 97. 402-K-97



No. 101s. 402-K-1019



No. 101. 402-K-101



No. 102. 402-K-102



No. 103. 402-K-103



No. 104. 402-K-104



No. 150. 402-K-150



No. 116.* 402-K-116



No. 121.* 402-K-121



No. 123*. 402-K-123



No. 124.* 402-K-124



No. 125.* 402-K-125



No. 126.* 402-K-126



No. 127.* 402-K-127



No. 127D.**
(Giant Rose).
402-K-1274

Basketweave Tips

44, 45 make smooth stripes; rest of basketweave tips make both smooth and ribbed stripes.



No. 44. 402-K-44



No. 45. 402-K-45



No. 46. 402-K-46



No. 47. 402-K-47



No. 48. 402-K-48



No. 1D.** 402-K-1004



No. 2B.*
402-K-2002

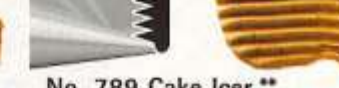
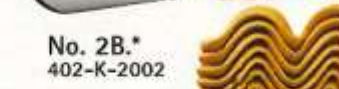

No. 789 Cake Icer.**
409-K-789

Specialty Tips

Shells, ropes, hearts, Christmas trees, ring candle holders!



No. 98. 402-K-98



No. 347. 402-K-347



No. 136. 402-K-136



No. 77. 402-K-77



No. 78. 402-K-78



No. 83. 402-K-83



No. 96. 402-K-96



No. 79. 402-K-79



No. 105. 402-K-105



No. 80. 402-K-80

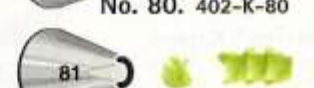

No. 81. 402-K-81

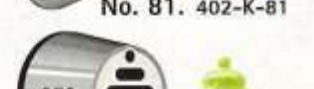

No. 250.* 402-K-250



No. 252.* 402-K-252



No. 95. 402-K-95

*Fits large coupler.

**Tip does not work with coupler. Use with parchment or uncut bags only.

DECORATING UTENSILS & EQUIPMENT



DECORATING TUBES—Thermo

Description	Dimensions	Code
Plain Tubes No. 1	1mm	2UTPL1
No. 3	3mm	2UTPL3
No. 5	5mm	2UTPL5
No. 7	7mm	2UTPL7
No. 9	9mm	2UTPL9
No. 11	11mm	2UTPL11
No. 13	13mm	2UTPL13
No. 15	15mm	2UTPL15
No. 17	17mm	2UTPL17
No. 20	20mm	2UTPL20
Set of 7 (Plain)—No's. 3-15		2UTPLSET
Star Tubes No. 3	3mm	2UTST3
No. 5	5mm	2UTST5
No. 7	7mm	2UTST7
No. 9	9mm	2UTST9
No. 11	11mm	2UTST11
No. 13	13mm	2UTST13
No. 15	15mm	2UTST15
No. 17	17mm	2UTST17
Set of 7 (Star)—No's. 3-15		2UTSTSET

DECORATING TUBES—Metal

Description	Dimensions	Code
Plain Tubes No. 1	4mm	1CT1
(see previous pages for pictures) No. 2	6mm	1CT2
No. 3	8mm	1CT3
No. 4	10mm	1CT4
No. 5	12mm	1CT5
No. 6	14mm	1CT6
No. 7	16mm	1CT7
No. 8	18mm	1CT8
No. 9	20mm	1CT9
No. 10	22mm	1CT10
No. 11	24mm	1CT11
No. 12	26mm	1CT12
No. 2A		1CT2A
No. 1A		1CT1A
Set of 10 Plain—No's. 0-9		I50460-10
Open Star Tubes No. 13	2mm	1CT13
No. 14	4mm	1CT14
No. 15	6mm	1CT15
No. 16	8mm	1CT16
No. 17	10mm	1CT17
No. 18	12mm	1CT18
No. 19	14mm	1CT19
No. 20	16mm	1CT20
No. 21	18mm	1CT21
No. 32		1CT32
No. 199		1CT199
No. 362		1CT362
No. 363		1CT363
No. 364		1CT364
No. 172		1CT172
No. 2110 (1M)		1CT1M
No. 4B		1CT4B
No. 6B		1CT6B
No. 8B		1CT8B
Set of 10 Star—No's. 0-9		I50470-10
Closed Star Tubes No. 24		1CT24
No. 26		1CT26
No. 27		1CT27
No. 28		1CT28
No. 29		1CT29
No. 30		1CT30
No. 31		1CT31
No. 33		1CT33
No. 35		1CT35
No. 133		1CT133
No. 54		1CT54



DECORATING UTENSILS & EQUIPMENT

DECORATING TUBES—Leaf

Description	Dimensions	Code
Leaf Tube No. 112	10mm	1CT112
No. 113	13mm	1CT113
No. 114	17mm	1CT114
No. 115	20mm	1CT115



DECORATING TUBES—Rose Petal

Description	Code
Rose Petal Tube No. 116	1CT116
No. 117	1CT117
No. 118	1CT118
No. 119	1CT119
No. 120	1CT120
No. 121	1CT121
No. 122	1CT122
No. 123	1CT123
No. 124	1CT124
No. 125	1CT125
No. 126	1CT126
No. 127	1CT127



DECORATING TUBES—Special Drop Flower

Tube No.	Code	Tube No.	Code	Tube No.	Code
129	1CT129	171	1CT171	217	1CT217
131	1CT131	172	1CT172	220	1CT220
132	1CT132	190	1CT190	221	1CT221
133	1CT133	191	1CT191	223	1CT223
134	1CT134	193	1CT193	224	1CT224
135	1CT135	194	1CT194	225	1CT225
137	1CT137	195	1CT195		
138	1CT138	199	1CT199		
139	1CT139				
140	1CT140				
146	1CT146				



DECORATING TUBES—Large Grass

Description	Dimensions	Code
Large Grass Metal Tube #234	15mm	Q00234



METAL TUBES—Christmas Tree & Heart

Description	Dimensions	Code
Christmas Tree	20mm	Q00250
Heart Shape	20mm	Q00252

DECORATING UTENSILS & EQUIPMENT

CREAM HORNS (Tin)

Description	Dimensions	Code
Large (Single)	140x 50mm	PCHM
Pack of 6 small (Tin)	110 x 40mm	3A3213
Pack of 6 Non-Stick	110 x 40mm	3A3214

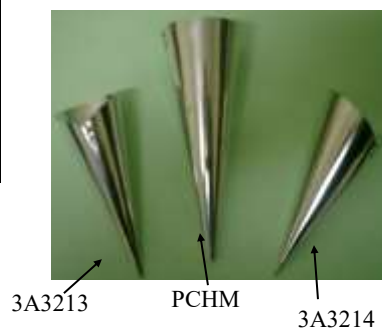

CANOLE TUBES

Description	Dimensions	Code
Canole Tube, Aluminium	22 x 140mm long	CCANOE22
Mondo Cannoli Tub Set of 4	20 x 140mm long	1B02MO612



CCANOE22

DECORATING CAKE STENCILS

Description	Dimensions	Code
Stork	250 mm	2UMS450
Number 25	250 mm	2UMS456
Number 50	250 mm	2UMS459
Lorenze	250 mm	2UMS460
Flower	250 mm	2UMS463
Tiramisu	250 mm	2UMS465
Sun	250 mm	2UMS532
Rose (Large)	250 mm	2UMS603



DECORATING UTENSILS & EQUIPMENT

CAKE SAW

Description	Dimensions	Code
HD Cake Saw with 2 Blades Extra Blades	460 x 240mm	2ULP53500 2ULP53510
Cake Leveller, Precisely levels & torts cakes up 10. in wide, adjusts to 2 in. high	300 x 160mm	1C0415085
Cake Leveller	54 x 18mm	1C04171198
Cake Cutter with serrated S/S wire	325 mm	I37526



2ULP53500



2ULP53510



1C0415085



I37526



1C04171198

MARZIPAN TOOL SET

Description	Dimensions	Code
Marzipan Tool Set 15 Pieces		2UMH12



2UMH12

FONDANT SMOOTHER

Description	Dimensions	Code
Fondant Smoother	145x80mm	1C19071200



1C19071200

ACETATE ROLL

Description	Dimensions	Code
Acetate Roll	40mm Wide 50mm Wide 60mm Wide	APWACE4 APWACE5 APWACE6



SPRAY BOTTLE

Description	Dimensions	Code
Bottle for spraying	1 ltr/260mm	1R116430



1R116430

DECORATING UTENSILS & EQUIPMENT

EASTER MOULDS

Description	Dimensions	Code
Small Cracked Egg Mould	90x60mm	3A84
Baby Bunny Mould / Set of 4	60x40mm	3A840
Junior Bunny Mould pk of 2	110x80mm	3A8402
Silicone Bunny Mould - Blue / Pink	140 mm	3A8406
Large Plain Egg Mould / single	110x80mm	3A84
Big Daddy Egg mould / single	182x110mm	3A8403
Rabbit Mould - tin	13 cm	3A2904
Half Cracked Eggs large / pk of 4	140x85mm	1R382023
Half Cracked Eggs small / pk of 4	88x65mm	1R382022
Half Plain Eggs	98x65mm	1R382028
Fish, Shells, Snails / pk of 20	32x21x19mm	1R380200
Bells / pk of 15	55x44x4mm	1R380204
Decorated hearts / pk of 24	40x40x12mm	1R380207
LIS Flowers / pk of 28	37x31x19mm	1R380210
Holly Leaves / pk of 14	55x30x4mm	1R380209
Chess Pieces / pk of 16		1R380222
Shells	36x35x12mm	1R380221
Leaves / pk of 21	60x30x4mm	1R380228
Rabbit / pk of 2	124x90mm	1R382012
Dolphins / pk of 8 halves	L70	1R380245
Various Easter/ pk of 25	30x25x5mm	1R382001
Flowers / pk of 20	45x4mm	1R380243
Scallop / pk of 2	120x139mm	1R382009
Coffee Beans / pk of 104	17x12x5mm	1R380211
Coffee Beans / pk of 78	22x25x8mm	1R380212
Hearts plain / pk of 36	25x25x9mm	1R380205
Heart with 2 roses / pk of 36		
Chocolate Dipping Set S/S		2UCD41735

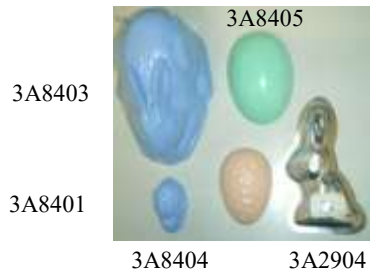

MEASURING

MEASURING SCOOPS		
Description	Dimensions (Volume/Length)	Code
Closed Front (Thermo Hauser) (suitable for liquid)	25ml 135mm 50ml 160mm 100ml 200mm 250ml 260mm 500ml 315mm 1000ml 385mm	Q31070 Q31071 Q31072 Q31073 Q31074 Q31075
Alumin. Round Bottom Professional	5oz 12oz 24oz 38oz 58oz 85oz	Q66012I Q66016I Q66020I Q66023I Q66026I Q66030I
Alumin. Flat Bottom H/D Professional	16oz 23oz	Q66155 Q66165
Alumin. Flat Bottom	4oz 8oz 16oz	I60021 I60022 I60025
Stainless Steel Scoop	30 x 100mm 75 x 150mm 100x190mm 120x235mm 155 x 250mm	1QSCOOP1 1QSCOOP2 1QSCOOP3 1QSCOOP4 1QSCOOP5
Plastic Carb Clear	24 oz	160124

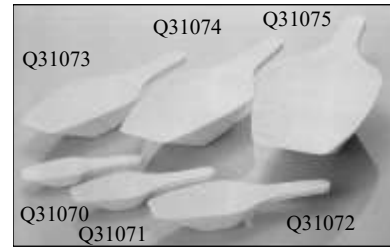

CHIP SCOOP		
Description	Dimensions	Code
Chip Bagging Scoop	210 x 230mm	I69272



MEASURING SPOONS		
Description	Dimensions	Code
S/S - set 4, round		I70324
S/S - set 4, Aust. ralian Standard (joined)	1/4 teaspoon - 1 tablespoon	3D13747

COLOR CODED SCOOPS		
Description	Dimensions	Code
Scoop 500 g / 750ml	100 x 150 x 260mm	HCHR40
Scoop 750 g / 1000ml	138 x 185 x 310mm	HCHB41
Scoop 1000 g / 2000ml	160 x 225 x 360mm	HCHB42
Heavy Duty plastic scoops(temp 120C). Available in White, Red, Blue & Green		



ICE SCOOP		
Description	Dimensions	Code
Ice Scoop - flat bottom plastic	1000ml	Q66170



MEASURING



I70324



1QMT88006



MEASURING JUGS

Description	Dimensions	Code
S/S Graduated	0.5 ltr 1 ltr 1.5ltr 2 ltr	1QMT12103 1QMT12104 1QMT12105 1QMT12106
Plastic (Thermo Hauser)	0.25 ltr 0.50 ltr 1 ltr 2 ltr 3 ltr 5 ltr	2ULP48006 2ULP48016 2ULP48156 2ULP48026 2ULP48036 2ULP48046

MEASURING CUPS

Description	Dimensions	Code
S/S - set 4	Cup sizes 60 - 250ml	I70329
S/S - set 4 deluxe	Cup sizes 60 - 250ml	I70330
S/S - set 4 (joined)	Cup sizes 1, 1/2, 1/3, 1/4	3D13746
'Pourfect' Bowl Set: 1, 2, 4 Cup—pk of 3 6, 8, 12 Cup—pk of 3 1, 2, 4, 6, 8, 12 Cup—pk of 6		W83005 W38012 W83015
Measuring Cup Set—9 pc		W83046

SHOVELS

Description	Dimensions	Code
Plastic Deep Pan T-Grip		HCHB23
Plastic Red Shovel M Blade T-Grip		HCHR03
Plastic White Shovel T-Grip		HCHWO3

FUNNELS

Description	Dimensions		Code
	Height	Diameter	
With Suspension Hook (Thermo Hauser)	115	80	Q31080
	125	100	Q31081
	145	115	Q31082
	195	155	Q31084
Stainless Steel Pie Funnel	250	245	1QMT88006
Plastic - set of 3			1F98568

MEASURING



PRICE COMPUTING SCALE		
Description	Dimensions	Code
Model: SF-6KA Model: SF-15KA Model: SF-30KA	3/6kg x1/2g 6/15kgx2/5g 15/30kgx5/10g	2GSF-6KA 2GSF-15KA 2GSF-30KA
Dual range operation for Max accuracy S/S Pan is ideal for the food industry VF Display & Rechargeable battery or AC adaptor power NSC approved for trade		



2GSK-20K



2GSJ-12KHS



2GSCALE

SCALES—DIGITAL

Description	Dimensions	Code
SK SERIES BENCH SCALES 5kg x 1g 5kg x 2g 10kg x 5g 20kg x 10g 30kg x 20g		2GSCALE51 2GSCALE5K 2GSCALE10K 2GSCALE20K 2GSCALE30K
SK WPSERIES S/S bench top Water proof Scales approved for trade use Also available in 15 kg	230X195mm	2GSK-5KWP 2GSK-10KWP 2GSK-20KWP
Glass Kitchen Scale Black / White	230x135mm	Y1041B
S/S Kitchen Scale	90x90mm	Y1004SS
SJ-HS Bench Scale Fast weighing Response 1kg x 0.5g 2kg x 1g 5kg x 2g 12kg x0.005kg	230x190mm 230x190mm 230x190mm 230x190mm	SJ-1KHS SJ-2KHS SJ-5KHS SJ-12KHS
Platform Scale big LCD Back light 10 kg 60 kg 100 kg 220 kg	250 x 250 mm 330 x 424mm 390 x 530mm 390 x 530mm	2GHW-10KGL 2GHW-60KGL 2GHW-100KGL 2GHW-200KGL
HV model Approved for trade use		



Y1041B



Y1004SS



2GHW-60KGL

MEASURING

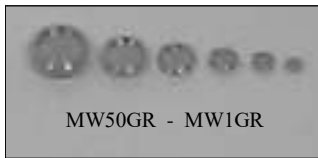

WEIGHTS

Description	Dimensions	Code
1 gram Brass 2 gram Brass 5 gram Brass 10 gram Brass 20 gram Brass 50 gram Brass Weights Set - 5gr - 2kg Weights Set - 5gr-5kg 100 gram Cast Iron 200 gram Cast Iron 500 gram Cast Iron 1kg Cast Iron 2kg Cast Iron 5kg Cast Iron		MW1GR MW2GR MW5GR MW10GR MW20GR MW50GR MW7KGSET MW14KGSET MW100GR MW200GR MW500GR MW1KG MW2KG MW5KG
Weights Imperial - Set 7 (Salter) Solid Brass - Bell Shape	11lb, 8oz, 4oz, 2oz, 1oz, 1/2oz, 1/4oz	3D70631
Weights Metric - Set 9 (Salter) Solid Brass, bell shape	500gm, 2 x 200gm, 100gm, 50gm, 2x20gm, 10gm, 5gm	3D70632

SCALES—KITCHEN

Description	Dimensions	Code
Scale 1kg x 5g GRAD Scale 5kg x 20g GRAD Scale 10kg x 40g GRAD Scale 22kg x 100g GRAD S/S Dial Spring Scale with flexible top S/S Mechanical Sweetie Scale	3kg	Q05361 Q05363 Q05364 Q05365 I 31165 Y108CH

SCALES—BALANCE

Description	Dimensions	Code
Balance Scale	10kg	PSC10

MEASURING

SCALES—HANGING

Description	Capacity	Code
Model 235-6s (Salter) 150 mm diameter dial Available in 10, 25, 50 and 100kg	5kg x 20g	2H235-6S
Model 235-10S (Salter) 225mm diameter dial Available in 10, 25, 50 and 100kg	5kg x10g	2H235-10S
Model 235-10X (Salter) Trade version includes internal damping mechanism, 255mm dial. Available in 10, 25, 50, 100 and 500kg	5 kg x10g	2H235-10X



2H235-6S



TIMERS

Description	Dimensions	Code
Big Time - Electronic	19hr 59min countdown x 1min	Y336
Countdown Timer - Electronic	19hr 59min count down/up	I30785
Digital T 3 Timer	90x70mm	3H-Timer
Mechanical Timer- 60 minutes	90x90mm	Y338
60 Minute Timer Square	70x70mm	3A3473



Y336



3H-Timer



Y338



I30785



Q050394

MEASURING

THERMOMETERS			
Description	Temp.	Dimensions	Code
Infra gun Thermometer		150x70mm	3HAZ8889
Infrared Thermometer 2 in 1		270x55mm	3HHACCRD
Pocket Temp/Safe for Food digital	-50°C to +200°C	200mm	3HP-Temp
Fridge/Freezer Stainless Steel	-30° to +30°C	60mm	3HT-Tee
Fridge/freezer Thermometer		65x48mm	I30805
Oven S/S Dual	+50° to +300°C		Q05385
Oven thermometer	+10° to +230°C		1F98572
Meat Thermometer	+60° to +185°C	120mm	1F98575
Pocket Thermometer Dual	-10° to +100°C	140mm	Q05371
Coffee Thermometer S/S	0° to +100°C 0° to +150°C	160mm 210mm	3H-coff-S 3H-Temp
Pocket Thermometer	-37.8°C to +140°C	140mm	Q05371
Pizza Thermometer	0° to +400°C	210m	3HPIZ-Temo
Fridge/Food Electronic Thermometer	-50°C to +260°C	110mm	3HPTM50150
Display Thermometer & Glass Digital mount kit Attach to inside or out	-50°C to +70°C	120x55mm	3HPD72
Cook/Chill Thermometer	-50°C to +300°C	100x65mm	3H-CookChill
Tiny-Tee Thermometer	-50°C to +200°C	160mm	3H-Tee
Easy read wall Thermometer		360x88mm	3A3023
K-Type Thermometer		150x70mm	3HT1311
Stainless Steel Deep Fry/Candy	+37.8° to +204.4°C	310mm	1R250331
Clip to suit deep fry/ candy			1R250500
Thermometer Probe Wipes/Sterile HACCP Approved		QTY: 100 Sachets	3HPWIPES



3HAZ8889



3HP-Temp



3HPTM50150



3HPD72



3HHACCRD



3H-Tee



3H-CookChill



3HPWIPES



1R250331



3HT1311



I30805



3A3023

KNIVES & SHARPENERS



KNIFE CASES

Description	Dimensions	Code
Knife Safe Carry Case—grey, blue, red	300 x 400mm	AMKSC
Red knife/tool box	240 x 400mm	AP1003RE



BONING KNIVES (Victorinox)

Description	Dimensions	Code
Nylon handle	12cm	A5.6603.12
Wood handle	15cm	A5.6000.15
Curved edge (wooden handle)	15cm	A5.6300.15
Nylon handle	15cm	A5.6503.15
Wood handle	15cm	A5.6600.15
Nylon handle - Black	15cm	A5.6603.15



BREAD KNIVES (Victorinox)

Description	Dimensions	Code
Bread Knife - Wavy Edge (wood handle)	18cm	A5.1630.18
Bread Knife - Wavy Edge (wood handle)	21cm	A5.1630.21
Bread Knife - Wavy Edge (nylon handle)	21cm	A5.1633.21
Forged Knife - Wavy Edge (nylon handle)	21cm	A7.7173.21

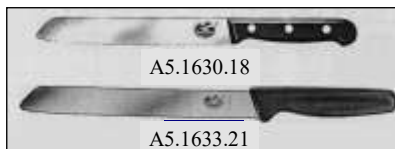

CARVING KNIFE/COOKS KNIFE (Victorinox)

Description	Dimensions	Code
Wavy Edge	18cm	A5.1930.18
Wood handle	19cm	A5.2000.19
Wood handle	22cm	A5.2000.22
Wood handle	25cm	A5.2000.25
Wood handle	31cm	A5.2000.31
Fibrox handle	19cm	A5.2003.19
Fibrox handle	22cm	A5.2003.22
Nylon handle	25cm	A5.2003.25
Nylon handle	31cm	A5.2003.31

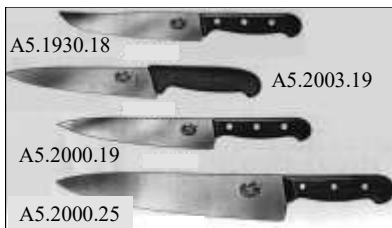

KNIVES & SHARPENERS

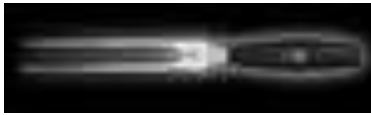

HEAVY DUTY GERMAN KNIVES (FOUR STAR)

Description	Dimensions	Code
Carving Knife	20cm	1F60012
Carving Knife (Flexible Blade)	23cm	1F60013
Carving Knife (Flexible Blade)	26cm	1F60014
Boning Knife	14cm	1F60015
Filleting Knife	18cm	1F60016
Bread Knife	20cm	1F60017
Carving Knife	18cm	1F60018
Cook's Knife	16cm	1F60019
Cook's Knife	20cm	1F60020
Cook's Knife	23cm	1F60021
Cook's Knife	26cm	1F60022
Santoku Knife	18cm	1F60027

* Forged Knives: Won't rust or stain
 * Stay sharper Longer,
 * Proper balance & greater strength
 * Moulded handles are smooth and hygienic
 * Food safe, stylish, break proof
 * Dishwasher safe



MISCELLANEOUS

Description	Dimensions	Code
Melon baller with plastic handle Different size S/S scoop at each end	165x25mm	A7.6163
Apple corer, plastic handle, S/S top	16mm	A5.360316



CUT RESISTANT GLOVE

Description	Code
Cut Resistant Glove, different sizes & colours available	A7.9031.M
Chain Mail—5 digit	KG-MEXTRA5



SUPER SCHERE SCISSOR

Description	Dimensions	Code
Super schere scissor, plastic handle & S/S blades	200mm	A7.6363.3



KNIVES & SHARPENERS

CIMETER/BUTCHERS KNIFE (Victorinox)

Description	Dimensions	Code
Cimeter Steak Knife (wide curve)	25cm	A5.7300.25
Cimeter Steak Knife (wood Handle)	36cm	A5.7300.36
Breaking Knife (nylon handle)	20cm	A5.7203.20

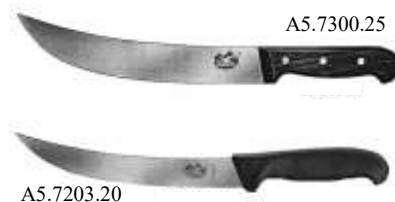

CLEAVERS (Victorinox)

Description	Dimensions	Code
S/S	18cm/590g	A5.400
S/S	18cm/320g	A5.4003.18
S/S Forged (wood handle)	20cm/900g	A7.7250.20
S/S Forged (nylon handle)	20cm/900g	A7.7253.20



DOUGH KNIFE (Victorinox)

Description	Dimensions	Code
Wood Handle - rounded tip	20cm	A5.7400.20
Wood Handle - rounded tip	25cm	A5.7400.25
Wood Handle - rounded tip	36cm	A5.7400.36
Nylon Handle - rounded tip	20cm	A5.7403.20
Nylon Handle - rounded tip	23cm	A5.7403.25
Nylon Handle - rounded tip	31cm	A5.7403.31

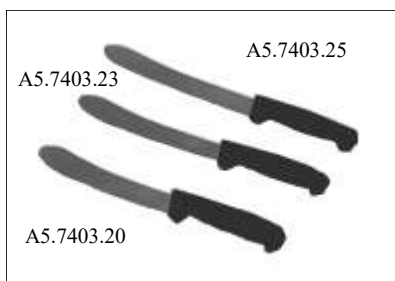

KNIFE SHARPENER

Description	Dimensions	Code
Stable, easy to use, made in Germany		
Black	165 x 46mm	1F60450
White	165 x 46mm	1F60451
Manual Diamond Hone Knife sharpener 2 stage 450	175 x 53mm	ACC450
Multi Edge Diamond Knife sharpener For Straight & Serrated edge knives, 2 stage 460	175 x 55mm	ACC460



BAKERS BLADE

Description	Dimensions	Code
Bakers blade, plastic handles	50x22mm	1R120005



KNIVES & SHARPENERS

STRAIGHT PARING KNIVES (Victorinox)

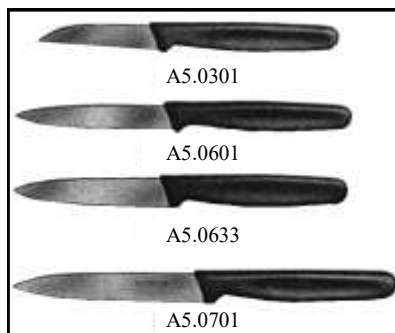

Description	Dimensions	Code
Red Straight	6cm	A5.0301
Black Straight	6cm	A5.0303
White Straight	6cm	A5.0307
Red Pointed	8cm	A5.0601
Blue Pointed	8cm	A5.0602
Black Pointed	8cm	A5.0303
White Pointed	8cm	A5.0304
Red Pointed	10cm	A5.0701
Blue Pointed	10cm	A5.0302
Black Pointed	10cm	A5.0703
White Pointed	10cm	A5.0707
(also available in wood handles)		

WAVY EDGE PARING KNIFE



Description	Dimensions	Code
Paring knife, curved tip (available in: black, red, blue & white)	8cm	A5.0433
Paring knife, pointed tip (available in: black, red, blue, & white)	8cm	A5.0603
Paring knife, pointed tip (available in: black, red & white)	10cm	A5.0733
Steak Knife:		
Red	11cm	A5.0831
Blue	11cm	A5.0832
Black	11cm	A5.0833
White	11cm	A5.0837
(all available in wood handles)		

SHAPING KNIFE (Victorinox)



Description	Dimensions	Code
Rosewood Handle	6cm	A5.3100
Nylon Handle (Available in: red, white & black)	6cm	A5.3103

PASTRY KNIFE



Description	Dimensions	Code
Fibrox handle	26cm	A5.2933.26

SLICING KNIFE (Victorinox)

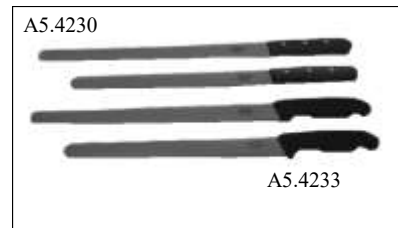

Description	Dimensions	Code
Wood handle—round Tip	25cm	A5.4230.25
Rosewood Handle—round tip	30cm	A5.4230.30
Rosewood Handle—round tip	36cm	A5.4230.36
Nylon Handle—round tip	25cm	A5.4203.25
Nylon Handle—round tip	25cm	A5.4233.25
Nylon Handle—round tip	30cm	A5.4233.30
Nylon Handle—round tip	36cm	A5.4233.36
Wood handle—pointed tip	25cm	A5.4430.25
Rosewood handle—pointed tip	30cm	A5.4430.30
Nylon Handle—pointed tip	25cm	A5.4433.25
Slicing Knife (Tramontina)	25cm	1B05PM521

KNIVES & SHARPENERS

CHEESE KNIFE		
Description	Dimensions	Code
2 Nylon Handles	30cm 36cm	A6.1203.30 A6.1203.36



SHARPENING STEEL (Victorinox)		
Description	Dimensions	Code
Round	270mm 300mm	A7.8333 A7.8413
Wood handle	300mm	A7.8510

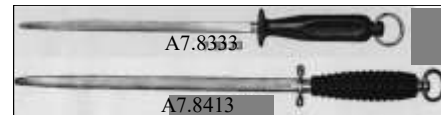
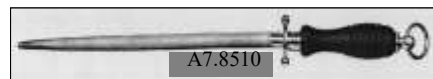

CHEF'S CASE		
Description	Dimensions	Code
Chef's Case		A5.4914



KNIFE SETS		
Description	Handle material	Code (set)
8pc Pro Gourmet Set: kitchen cleaver A5.4003.18 carving knife A5.1803.18 carving fork A5.2103.15 carving knife A5.1903.19 flexible spatula A5.2603.20 bread knife, wavy edge A5.1633.21 sharpening steel A7.8213 carving knife A5.1903.22	Polypropylene	A5.1143.8
7pc Gourmet Set: carving fork A5.2103.15 paring knife A5.0603 bread knife, wavy edge A5.1633.18 tomato knife, wavy edge A5.0833 flexible spatula A5.2603.20 potato peeler A5.0103 carving knife A5.1903.19	Rosewood Polypropylene	A5.1100.7 A5.1103.7
7pc Gourmet Set: tomato knife A5.0830 paring knife A5.0600 potato peeler A5.0100 flexible spatula A5.2600.20 bread knife, wavy edge A5.1630.21 sharpening steel A7.8210 filleting knife A5.3700.20	Rosewood	A5.1090.7
5pc Assorted Knife Set: paring knife, wavy edge A5.0433 paring knife A5.0603 tomato knife, wavy edge A5.0833 carving knife A5.1903.19 bread knife, wavy knife A5.1633.21	Polypropylene	A5.1163.5
3pc Carving Knife Set: carving knife A5.2000.12 carving knife A5.2000.19 carving knife A5.2000.22	Rosewood	A5.1050.3



CUTTING BOARDS



Q04319



Q04344



1F4700



I40252

CUTTING BOARDS

Description		Dimensions	Code
Cutting Board - Polyethylene		250 x 400 x 13mm	Q04319
		300 x 450 x 13mm	Q04320
		350 x 510 x 13mm	Q04321
		450 x 610 x 13mm	Q04322
		380 x 510 x 19mm	I40352
		450 x 610 x 19mm	I40353
Cutting Board - Polyethylene	Green	300 x 460mm	Q04342
	Red	300 x 460mm	Q04348
	Yellow	300 x 460mm	Q04344
	Blue	300 x 450mm	Q04345
	Brown	300 x 450mm	Q04346
Cutting Board - Polyethylene		380 x 501 x 20mm	Q04352
Cutting Board Marble:		400 x 300 mm	1F4700
Cutting Board Rosewood		510 x 328 x 44mm	I40252
Cutting Board - Custom Made Various colours, sizes and thicknesses available		5,12,15,20 & 30mm	

FLEXIBLE CUTTING MATS—Wont dull your knives

Description	Dimensions	Code
Thin Clear Cutting mat		
Chopping Mat Flexible Variety of different colours available	300x375mm	3A9051



3A9051

Custom Cutting Board made to order

Available in various thicknesses 5-50mm & colours
Heavy Duty Quality for bench tops, European made,
500 density
Withstands high temperatures

MISCELLANEOUS UTENSILS

CAN OPENERS - Bonzer

Description		Code
Standard:	Regular Finish	Q05000
	Deluxe Finish S/S	Q05001
	Regular with Clamp Base	Q05006
	Deluxe Finish S/S with clamp	Q05007
Super:	Regular Finish	Q05002
	Deluxe Finish S/S	Q05003
Canmaster	Regular Finish	Q05012
	Deluxe Finish S/S	Q05015



REPLACEMENT PARTS (Bonzer can openers)

Description	Code
Blade	Q05000-B
Wheel for Canmaster	Q05012-W
Wheel for Standard/Super Model	Q05000-W
Clamp base	Q05000-C
Handle	Q05000-H
Plain base	Q5000-P

REGULAR & BENCH CAN OPENERS

Description	Code
Swing-A-Way Portable Can Opener Available in white, red, and black	3D0407
Can Opener - comfortable rubber grip, black	3D07092
Universal Can Opener Black (Victorinox)	A7.6857.3
'Lock-n-Lift' Can Opener (Zyliss) Non-slip handles, magnet attaches to lid for lifting, push button lid release	1F1363



MISCELLANEOUS UTENSILS



Q06850

I45289

I45286

SQUEEZE BOTTLES

Description		Dimensions	Code
Squeeze Bottle	Red	480ml, Height: 190mm	I45284
	Yellow	480ml, Height: 190mm	I45285
	Clear	480ml, Height: 190mm	I45286
Squeeze Bottle	Red	720ml, Height: 250mm	I45287
	Yellow	720ml, Height: 250mm	I45288
	Clear	720ml, Height: 250mm	I45289
Squeeze Bottle - Clear		1000ml, Height: 280mm	Q06850
Squeeze Bottle— Tomato shape, red		250ml, Height: 110mm	3A4367



Q07675

STRAW DISPENSER

Description	Dimensions	Code
18/8 Stainless Steel Straw Dispenser	260 x 150 x 150mm	Q07675
Old Fashioned Straw Dispenser	230 x 80mm	1F55206



1F55206



Q07675



3A4306



D Fold

E Fold



3A4303

I70261



NAPKIN HOLDERS

Description	Dimensions (mm)	Code
Napkin Dispenser S/S "D Fold"	130 x 95 x 115 H	Q07282
Napkin Dispenser S/S "E Fold"	160 x 100 x 125 H mm	Q07285
Clear Plastic	80 x 80 x 60 H mm	3A4306
Clear Acrylic Letter	155 x 80 mm	3A4303
S/S Triangular	150 x 75 mm	I70261



Q04485

3Q04483

Q04486

Q04482

PEPPER MILL

Description	Dimensions	Code
Pepper Mill wood Mahogany	38cm	Q04485
Available in 2 different sizes	30cm	Q04482
Pepper Mill wood Birch	38cm	Q04486
Available in 2 different sizes	30cm	Q04483
Salt Shaker & Pepper Mill Set	15cm	I40506



I40506

MIXERS & FOOD PROCESSORS

DRINK MIXERS					
Description		Dimensions (mm)			Code
		Height	Width	Depth	
Milkshake mixers:	White Red Black	480	205	220	2ZDM21W 2ZDM21R 2ZDM21B



2ZDM21W



2ZDM21R



2ZDM21B

MINI POWER MIXERS		
Description	Dimensions	Code
Mini power mixer 8ltr Capacity, 220W; 1A	170mm shaft	1MMP170 VV
Mini power mixer 12ltr Capacity, 280W; 1.2A	220mm shaft	1MMP220 VV



MIXERS & FOOD PROCESSORS



STICK BLENDERS

Description	Dimensions	Code
COMPACT POWER MIXER: CMP250 VV - 15ltr capacity 270W CMP300 VV - 30ltrCapacity 300W CMP350 VV - 45ltrCapacity 350W	250mm shaft 300mm shaft 350mm shaft	1MCMP250 1MCMP300 1MCMP350
MP-LARGE POWER MIXER MP350 - Process up to 50 litres, 400W MP450 - Process up to 100 litres, 450W MP550 - Process up to 200 litres, 600W MP 600 - Process up to 300 litres, 750W	125mm 125mm 125mm 125mm	1MMP350 1MMP450 1MMP550 1MMP600
LARGE COMBINATION MIXER MP350 - COMBI - 50ltrCapacity MP450-COMBI - 100ltr Capacity	350mm: Mixer 280mm: Whisk 450mm: Mixer 280mm: Whisk	1MMP350 1MMP450

- Handle is ergonomically shaped to give the best grip and is fitted with watertight control buttons (photo 1 below).
- Models are fitted with safety button (A), on-off control button (B) and if continuous operation is required lock button (C) (photo 2 below).
- The “Bell” is easily removed without the use of any tools and is double sealed for watertightness guaranteeing hygiene and long life.
- The knife is one piece stainless steel and has been overmoulded to give maximum hygiene. The design of the knife gives optimum speed and quality of cut (photo 3 below).

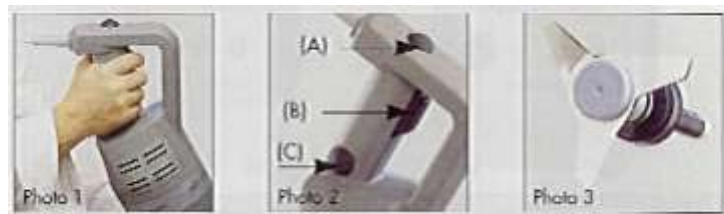

MIXERS & FOOD PROCESSORS

FOOD PROCESSORS/VEGETABLE PREPARATION

Description	Code
<u>VEGETABLE CUTTING MACHINES</u>	
375rpm, S/S discs Fruit & vegetable preparation, dices, processes French Fries	1MCL30
CL52-375rpm, 650W; 240V; 300mm	1MCL52
CL55-375rpm, 900W; 240V; 400mm	1MCL55
375Rpm, 2 hoppers, S/S discs, continuous feed	1MCL50
<u>COMBINATION FOOD PROCESSOR</u>	
1500rpm, 1.6 litre bowl, 2mm grater & 2mm slicer, 1/3 HP single phase	1MR101
1500rpm, 2.5 litre bowl, 2mm grater & 2mm slicer, 1/3 HP single phase	1MR201
1500rpm, 3.5 litre bowl, 0.68 HP single phase	1MR301
1500rpm, 4ltr S/S bowl & veg. head attachment , 700W; 240V	1MR401
3000rpm in Cutter mode, 1000rpm for vegetable slicer mode, 1000W, 240V French Fry & dicing equipment available	1MR402 VV
750/1500Rpm, 5.5 litre S/S bowl, 0.6/1.2 PH three phase	1MR502
1500Rpm, 3.5 litre S/S bowl, 0.68 HP single phase	1MR301U
300-3000Rpm, 6.5 litre S/S bowl, 2 HP single phase	1MR602V.V



1MCL50



1MCL30



1MR502



1MCL55



1MR602V.V



1MR502



1MR301U



1MR402 VV



Dicing disc

Julienne disc

Slicer disc A

Slicer disc B

Parmesan disc

Grating disc

MIXERS & FOOD PROCESSORS



1MR2-S



1MR2-P



1MR3S/1500



1MRPLUS/1



1MR4 VV

FOOD CUTTER/MIXERS

Description

Code

Table Top Cutter/Mixer

R2-P 1500rpm, 550W; 240V; 180mm; 2.5ltr bowl

1MR2-S

R2-P, 1500rpm, 550W; 240V; 180mm; 2.9ltr bowl

1MR2-P

R3-P/1500rpm, 650W; 240V; 210mm; 3.5ltr bowl

1MR3S/1500

R3-P/3000rpm, 650W; 240V; 210mm; 3.5ltr bowl

1MR3S/3000

R4 PLUS/1 Single Speed: 1500rpm; 700W; 240V; 226mm; 4ltr b

1MRPLUS/1

R4 PLUS/3 Two-speed: 1500 & 3000rpm; 3phase; 900W; 415V; 4ltr b

1MR4PLUS/3

R4 VV; Variable Speed: 300 to 3000rpm; 1000W; 240V; 4ltr b

1MR4 VV

* Pulse command, hardwearing S/S motor shaft

* Safety system

* Machine stopped as soon as the cover is opened

* Liquid can be added while processing

* Comes with S/S bowl & straight blade knife

MIXERS & FOOD PROCESSORS



1MBLIXER3

FOOD BLIXERS	
Description	Code
<u>BLIXER 3</u>	
Blixer 3 - 3000rpm, 750W; 240V; 200mm; 3.5ltr S/S bowl	1MBLIXER3
Blixer 4 - 3000rpm, 750W; 240V; 226mm; 4ltr S/S bowl	1MBLIXER4
Blixer 5 - 3000rpm, 750W; 240V; 280mm; 5.5ltr	1MBLIXER5
Blixer 5VV; Variable Speed: 300 to3000rpm 1400W; 240V	1MBLIXER5VV
Blixer 6VV; Variable Speed: 300 to3000rpm 1500W; 240V	1MBLIXER6VV
* Special flat metallic motor base	
* Automatic bowl locking with trigger release unlock	



1MBLIXER4

1MBLIXER6VV



1MBLIXER5VV



MIXERS & FOOD PROCESSORS



MANDOLINE VEGETABLE SLICER

Description	Code
Mandoline with 3 blades (Matfer)	1R215005
Pusher for Mandoline S/S (Matfer)	1R215001
Exoglass professional mandolin 2000 'S' Made in France	1R215060



1F1598



1F1338

1R215060



1F1530



SLICER AND GRATER

Description	Dimensions	Code
4-in-1 Slicer & Grater Dishwasher safe, top rack, non-stick rubber base	23 x 12mm	1F1338
Adjustable Slicer with food holder, Slicers from paper thin to 1/4", Non Slip feet		1F1598
Coarse Grater, S/S with non-slip handle & feet.	16 x 8mm	1F1530



1F10331

MANDOLINE VEGETABLE SLICER

Description	Code
Safety rail-guided slicer with 6 Blades Made in Switzerland	1F1031



1R215152

APPLE PEELER/SLICER & CORER

Description	Dimensions (mm)	Code
Apple Mate - One operation peels, slices & cores apples in seconds	240L x 180H	1R215152

Onion Chopper

Description	Dimensions (mm)	Code
Dice Onion in one Swift Motion Encloses onion to minimize odours & reduce tearing Dishwasher safe	270 x 110 x 60	1F55120



1F55120

PASTA AIDS

PASTA AIDS		
Description	Dimensions	Code
<p>Pasta making machine</p> <p>4 different shaped pasta cutters: spaghetti , lasagne ricce, lasagnette & ravioli as well as a pasta cutter utensil.</p> <p>Set of 3 dough shapers will quickly make ravioli & calzone.</p> <p>Electric motor can be attached.</p> <p>Made in Germany</p>	125 x75mm	1NJULIA150



PASTA AIDS

Ravioli Cutters		
Description	Dimensions	Code
Ravioli Cutter S/S Base & wooden handle Available in 3 different sizes	60mm 50mm 40mm	Q03396 Q03395 Q03394

Q03395



Q03396



Q03394



Ravioli & Pastry wheel		
Description	Dimensions	Code
Ravioli & Pastry Cutter Wheel Large S/S Base & wooden handle.	165mm	Q03398

Q03398



ICE SLICERS

ICE SLICERS		
Description	Dimensions	Code
Available in 2 different models:		
WI-303	330 x 400 x 470 mm 210 Watts 5kg/min	TWI-303
WI-707	310 x 420 x 440 mm 250 Watts 5kg/min	TWI-707
Unparalleled performance, productivity & efficiency Large ice slicing capacity Reduced operational noise for quieter environment High grade S/S inner material for sanitary purposes Safety lid system		



JUICERS

JUICER/PEELER		
Description	Dimensions	Code
<p>Ruby 2000/2 O juicer</p> <ul style="list-style-type: none"> * Produces up to 1.5 Litres in 30 seconds * Automatic Pulp Ejection - S/S * 8 Different spout positions, making the Ruby suitable for any location * Requires minimal bench space * Net Weight: 26Kg / 750W / 220-240v * Safety deactivation switch on lid 	345W x 425D x 470H	RB-2000
<p>Mini Max O juicer</p> <ul style="list-style-type: none"> * Output: 15 orange per minute * Electrical Protection: Overload and temperature * Security: Automatic disconnection switch * Capacity of peel bucket: 9Kg * Net Weight: 52Kg / Power: 375W 220-240V 50Hz 	230W x 450D x 740H	ZM-MX
<p>Wheatgrass Juicer</p> <ul style="list-style-type: none"> * All stainless steel motorised juicer running at 50 rpm * Quick and easy to operate * Produces 40ml of juice from approx. 60 grams of wheatgrass * Net Weight: 7.3Kg * 75W 220-240V 50Hz 	150W x 450D x 350H	
<p>Peel-O-Matic</p> <ul style="list-style-type: none"> * Easy to use / Easy to clean * Fast & reliable, peeling up to 360 per hour (6 oranges per mi) . You can peel fruit such as Oranges, Lemons, Grapefruit Apples, Pears, Kiwis. Can peel any round fruit! * Net Weight: 3Kg S/S 	160W x 245D x 225H	



JUICE DISPENSER		
Description	Dimensions	Code
<p>FANCOR drink dispenser Available in 1,2,3 & 4 x 12 Litre capacity</p>		
<p>1 x 12 Litre bowl Net Weight: 20Kg Power: 120W 220-240V50Kz</p>	260W x 430D x 650H	FANCOR112
<p>2 x 12 Litre bowl, Net Weight: 30Kg Power: 180W 220-240Hz</p>	410W x 430D x x650H	FANCOR212
<p>3 x 12 Litre bowl, Net Weight: 35Kg Power: 230W 220-240V 50Hz</p>	610W x 430D x 650H	FANCOR312
<p>4 x 12 Litre bowl, Net Weight: 45Kg Power: 360W 220-240V 50Hz 2 Compressor Unit</p>	820W x 430D x 650H	FANCOR412







FANCOR112



FANCOR412

Spray Guns (KREA Swiss)

<p>Multi Purpose</p> 	<p>The multiSPRAY (LM25):</p> <p>Our most versatile all rounder. The chefs` favourite for applying egg, oil, butter, glaze, fondant, chocolate mix, marinades and sauces etc. Bakers love it for the ease of greasing baking sheets & tins.</p> <p>Main Users: chefs, bakers Viscosity*: max 80 DIN/sec Delivery Rate*: 250g/min (water)</p>
<p>For Volume</p> 	<p>The volumeSPRAY (LM45):</p> <p>For higher volumes spraying of medium to thick materials from a much larger container. Widely used for egg and glaze. Larger piston capacity than the multiSPRAY (LM25) - too powerful for light oils.</p> <p>Main Users: larger production areas Viscosity*: max 100 DIN/sec Delivery Rate*: 350g/min (water)</p>
<p>NEW</p> <p>For Oils</p> 	<p>The oilSPRAY (LM2):</p> <p>Designed for spraying thin to medium materials such as oil and water. Configured to deliver a volume of as low as 80g/min. Lighter, quieter and minimal overspray compared to more powerful guns.</p> <p>Main Users: fast food, pizza, bakery Viscosity*: 18-36 DIN/sec Delivery Rate*: 80-140g/min</p>
<p>NEW</p> <p>For Chocolate</p> 	<p>The hotCHOC (LM3):</p> <p>This innovative heated chocolate sprayer has been designed specifically to spray a warm mixture of 50% chocolate & 50% cocoa butter: finishing, velvet, moulds, speckling pralines, cakes etc. Heating & insulation reduces nozzle clog.</p> <p>Main Users: chocolate artisans & pastry chefs Viscosity*: 20-28 DIN/sec Delivery Rate*: 120-200g/min</p>
<p>NEW</p> <p>Less Mess</p> 	<p>The sprayBOX:</p> <p>Limits spread of spray, reduces cleaning. Simple to assemble and large enough to rotate a standard baking tray inside. Saves space and money compared to an industrial built in spraying unit. Swiss quality, hand made metal base & frame. Light reflecting & easy to clean fabric.</p> <p>Main Users: all spray gun users</p>

Produced in Switzerland, KREA Swiss products are renowned for their reliability, a result of their engineering and component quality and testing 100% of our sprayers before they leave the factory. They are packed with quality features and are designed specifically for the professional user. Those components in contact with food are certified as food safe. The sprayers are also easy to take apart for thorough hygienic cleaning.

Our goal is to provide high quality, reliable and innovative spraying solutions that help make the lives of professional users that little bit easier - something we`ve been doing successfully since the 1940`s.

Our expanding range of food preparation spraying solutions provide bakers, chefs, fast food chains and chocolate artisans with a range of products that allows them to work quickly and efficiently, saving time and reducing material waste.

BAKING SHEETS & TRAYS

HAMBURGER BUN TRAYS

Description	Dimensions	Code
Shallow	89mm diameter	LAHP92-02
Shallow	102mm	LAHP102-02
BR/PG	102mm diameter	LAHS102-02
Deep	127mm diameter	LHS127-02



ASSORTED TRAYS/LONG ROLL/HOT DOG

Description	Dimensions	Code
Baton Roll Trays Batched in 3's	Mould - 150 x 51mm Depth - 10mm	LATP150G3
Hot Dog Roll Trays Individual	Mould - 175 x 51mm Depth - 10mm	LATP175-02
Package Roll Trays	Depth - 39mm	LDPR200/6

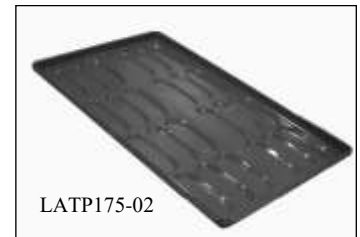

MUFFIN & CUPCAKE TRAYS

Description	Dimensions	Code
Mini Muffin Tray PG	50 cup T47/B31 x 25mm	LAHS47-02
American Style Tray PG	32 cup T70/B55 x 35mm	LWE70-15
Texas Muffin Tray PG	18 cup T88/B66 x 45mm	LWE88-15
Pan H/Duty Aluminium	12 cup T70/B53 x 30mm	Q66312
Pan H/Duty Aluminium	24 cup T70/B53 x 30mm	Q66324
Mini Muffin	12 cup T50/B40 x 25mm	1F94636
Regular Muffin	12 cup T70/B50 x 35mm	1F94631
Giant Muffin	6 cup T82/B75 x 32mm	3D9003
Patty Pan	12 cup	1F94632
Disposable Baking Cups	Mini/Regular/Giant	3F700
Yorkshire Pudding tray	4 cup T100/B80x18mm	1B01JC751
Pixie Bun	12 cup	1F94638
Tartlet/Mince Pie Pan	12 cup	3A2969



BAKING SHEETS & TRAYS

PERFORATED & NON PERFORATED TRAYS

Description	Dimensions	Code
Perf AL 5 Stick Tray P/Glased	16 inch	LASV5-02
Non Perf 5 Stick Tray P/Glased	16 inch	LSV5-02
Perf AL Flat Tray P/Glased	16 inch	LSWT16-02
Perf AL Tray 3 Sided	16 inch	LA1616R3P-02



PIE PALLETS

Description	Dimensions	Code
P1	3x6 = 18 pies - Width: 400mm	1ZP116
P1	4x6 = 24 pies - Width: 450mm	1ZP118
P1F	3x6 = 18 pies - Width: 400mm	1ZP1F16
P3	3x6 = 18 pies - Width: 400mm	1ZP316
R7F	3x6 = 18 pies - Width: 400mm	1ZR7F16
R10	5x11 = 55 pies - Width: 400mm	1ZR10
P8	5x10 = 50 pies - Width: 400mm	1ZP8
Panglazing Optional Teflon available in many sizes see page 4101		
18 Ring Frame S/S	3x6 = 18 pies - Width: 360mm	1ZRFP1F
Alcan167	Foil Size	

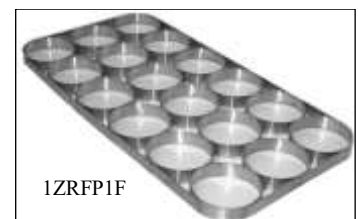

BAKING SHEETS & TRAYS

BAKING TRAYS/ALUMINIUM



CT1OE25AL



CT1CA25ST

Description	Dimensions	Code
4-Sided Aluminium	16" x 28" Closed 15mm	CT1CA15AL
4-Sided Aluminium	16" x 28" Closed 25mm	CT1CA25AL
4-Sided Aluminium	16" x 28" Closed 35mm	CT1CA35AL
4-Sided Aluminium	16" x 28" Closed 50mm	CT1CA50AL
4-Sided Aluminium	16" x 29" Closed 50mm	CT1CA50AL29
3-Sided Aluminium	16" x 29" Open 25mm	CT1OE25AL
4-Sided Aluminium	16" x 14" Closed 25mm	CT2CA25AL
4-Sided Aluminium	16" x 14" Closed 35mm	CT2CA35AL
4-Sided Aluminium	16" x 14" Closed 50mm	CT2CA50AL
3-Sided Aluminium	16" x 14" Open 25mm	CT2OE25AL
4-Sided Aluminium	26" x 18" Closed 25mm	CT3CA25AL
4-Sided Aluminium	26" x 18" Closed 50mm	CT3CA50AL
3-Sided Aluminium	26" x 18" Open 25mm	CT3OE25AL
Aluminium Flat Tray (slightly raised edges)	16" x 29"	CT1FLOOAL
Aluminium Flat Tray (slightly raised edges)	18" x 26"	CT3FL00AL
Gastronorm Tray 4-Sided Aluminium	530 x 325mm Closed 25mm	CT5CA25AL
Gastronorm Tray 4-Sided Aluminium	530 x 325mm Closed 50mm	CT5CA50AL
Gastronorm Flat Tray (slightly raised edges)	530 x 325mm	CT5FL00AL
4-Sided Aluminium	40 x 60cm Closed 15mm	CT6CA15AL
4-Sided Aluminium	40 x 60cm Closed 25mm	CT6CA25AL
4-Sided Aluminium	40 x 60cm Closed 35mm	CT6CA35AL
4-Sided Aluminium	40 x 60cm Closed 50mm	CT6CA50AL
3-Sided Aluminium	40 x 60cm Open 25mm	CT6OE25AL
Aluminium Flat Tray (slightly raised edges)	40 x 60cm	CT6FL00AL
4-Sided Aluminium	18" x 28" Closed 15mm	CT7CA15AL
4-Sided Aluminium	18" x 28" Closed 25mm	CT7CA25AL
4-Sided Aluminium	18" x 28" Closed 35mm	CT7CA35AL
4-Sided Aluminium	18" x 28" Closed 50mm	CT7CA50AL
3-Sided Aluminium	18" x 29" Open 25mm	CT7OE25AL
3-Sided (open wide end) Aluminium	18" x 29" Open (wide end) 25mm	CT7OEBD
Michel's Flat Tray	18" x 29"	CT7FLMP
4-Sided Aluminium	16" x 7" Closed 25mm	CT8CA25AL
4-Sided Aluminium	16" x 7" Closed 35mm	CT8CA35AL
4-Sided Aluminium	16" x 7" Closed 50mm	CT8CA50AL
Other sizes can be made to order		

BAKING SHEETS & TRAYS

BAKING TRAYS BLACK STEEL		
Description	Dimensions	Code
4-Sided Steel	16" x 28" Closed 25mm	CT1CA25ST
4-Sided Steel	16" x 28" Closed 50mm	CT1CA50ST
4-Sided Steel	16" x 14" Closed 25mm	CT2CA25ST
3-Sided Steel	16" x 29" Open 25mm	CT1OE25ST
Steel Flat Tray	400 x 735mm	CT1FLOOST

Other sizes can be made to order

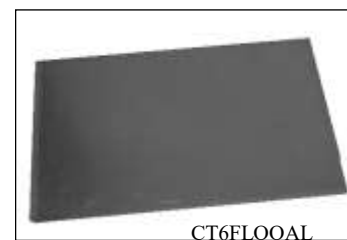

COOLING WIRES		
Description	Dimensions	Code
Heavy Duty	16" x 29"	CT1CWHDCP
Heavy Duty	16" x 29"	CT1CWHDSS
Heavy Duty	457 x 735mm	CT3CWHDCP
Heavy Duty	457 x 660mm	CT3CWHCP26
Heavy Duty	400 x 600mm	CT6CWHDCP

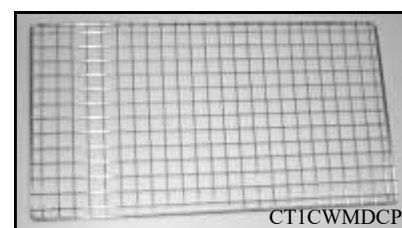

BAKING SHEETS & PAPERS		
Description	Dimensions	Code
Silicon Non Stick Mat	400x300mm	321000
	530x325mm	321001
	600x400mm	321002
	620x420mm	321003
	640x520mm	321004
Fibre glass Baking Sheet	400x700mm	LBS-16
	450x700mm	LBR-18
Silicon Paper		PK500



FERMENTING CLOTH		
Description	Dimensions	Code
Fermenting Cloth	600x1000mm	1R118560
	700x1000mm	1R118570
Per metre or full roll		



BAKING SHEETS & TRAYS (SILICONE)

FLEXIPAN MUFFIN & CUP CAKE TRAYS

Flexipan is perfect moulding without any breakage, even for products which are thought to be impossible. Small scale items can be manufactured economically. Trays and moulds can be cleaned easily.

Can be used at least 3000 times. Temperature from -40C to +300C

Description	Dimensions			Code
	Capacity	Diameter	Height	
<u>Muffins</u> 600x400mm	15 moulds	91mm	35mm	1R336047
	24 moulds	79mm	36mm	1R336045
	40 moulds	51mm	29mm	1R336023
<u>Florentines</u> 600x400mm	15 moulds	102mm	20mm	1R336024
	40 moulds	59mm	13mm	1R336018
<u>Tart Tatins</u> 600x400mm	12 moulds	100mm	35mm	1R336049
	15 moulds	82mm	30mm	1R336054
<u>Pies/ Quiches</u> 600x400mm	6 moulds	140mm	25mm	1R336051
	15 moulds	96mm	25mm	1R336132
	40 moulds	58mm	20mm	1R336130
<u>Pyramid</u> 600x400mm	24 moulds	71mm	41mm	1R336013
	54 moulds	35mm	23mm	1R336012
<u>Hearts</u> 600x400mm	20 moulds	62mm	35mm	1R336028
	20 moulds	62mm	25mm	1R336081
<u>Chestnuts</u> 600x400mm	24 moulds	64mm	26mm	1R336080
<u>Double Hearts</u> 600x400mm	8 moulds	113mm	35mm	1R336091
<u>Round Heart</u> 600x400mm	20 moulds	65mm	35mm	1R336082
<u>Mini Cones</u> 600x400mm	96 moulds	30mm	20mm	1R336039
Inset for Mini Cones	40 moulds	50mm	40mm	1R336035
<u>Cones</u> 600x400mm	20 moulds	70mm	60mm	1R336037
<u>Biscuits</u> 600x400mm	15 moulds	91mm	80mm	1R336038
	24 moulds	78mm	10mm	1R336048
<u>Assorted Delicacies</u> 300x400mm	30 moulds			1R336364
<u>Stars</u> 400x300mm	12 moulds	80x65mm	15mm	1R336330
600x400mm	24 moulds	80x65mm	15mm	1R336217
<u>Triangles</u> 600x400mm	80 moulds	41x48mm	10mm	1R336108



1R336047



1R336028



1R336039

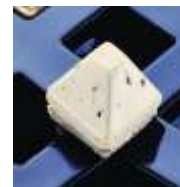

1R336013



1R336091



1R336082



1R336330



1R336038



1R336364



1R336108

BAKING SHEETS & TRAYS (SILICONE)

FLEXIPAN MUFFIN & CUP CAKE TRAYS

Description	Dimensions			Code
	Capacity	Diameter	Height	
<u>Charlottes</u> 600x400mm	18 moulds	78mm	40mm	1R336090
	24 moulds	62mm	35mm	1R336088
	60 moulds	35mm	15mm	1R336087
<u>Champagne Biscuits</u> 600x400mm	45 moulds	109x24mm	10mm	1R336128
<u>Mini Logs</u> 600x400mm	24 moulds	95x40mm	30mm	1R336126
	24 moulds	122x42mm	32mm	1R336137
<u>Fluted Brioche</u> 600x400mm	24 moulds	68mm	25mm	1R336061
	24 moulds	62mm	26mm	1R336060
	24 moulds	78mm	30mm	1R336063
	24 moulds	81mm	37mm	1R336016
<u>Rectangular Cakes</u> 600x400mm	24 moulds	80x30mm	30mm	1R336101
	25 moulds	89x46mm	25mm	1R336003
<u>Oval Savarin</u> 600x400mm	60 moulds	40x30mm	12mm	1R336123
	30 moulds	70x50mm	22mm	1R336125
	24 moulds	80x60mm	25mm	1R336124
<u>Silicone Decorating</u>	Length	Width		
Large Greek Frieze	600mm	400mm		1R422001
Small Greek Frieze	600mm	400mm		1R422002
Domes	600mm	400mm		1R422003
Dots & dashes	600mm	400mm		1R422004
Venetian	600mm	400mm		1R422005
Straight Flue	600mm	400mm		1R422006
Bubbles	600mm	400mm		1R422010
Rosette Cake Mat	600mm	400mm		1R422100
Spiral Cake Mat	600mm	400mm		1R422120
XMAS Log Mat	600mm	400mm		1R422130
<u>Decorative Plastic Stencils</u>				
Hexagons	600mm	400mm		1R441001
Hearts	600mm	400mm		1R441002
Circles	600mm	400mm		1R441003
Clover & Circles	600mm	400mm		1R441005
Ovals	600mm	400mm		1R441006
Squares	600mm	400mm		1R441007
Checkers	600mm	400mm		1R441008
<u>Multi moulds</u>				
Rounds	400mm	300mm		1R350001
Oval	400mm	300mm		1R350002
Rounds	600mm	400mm		1R350011
Ovals	600mm	400mm		1R350012
Pyramids	600mm	400mm		1R350020
Pushers (Round)	400mm	100mm		1R350021



1R336034



1R336396



1R336128



1R336061



1R336315



1R336434



1R336124



1R350001



1R441001



1R422100



1R422120



1R422003



1R422001



1R422010



1R422004



1R422006



1R422010



1R422130

BREAD PANS & ACCESSORIES

BREAD BAKING TINS

Description	Dimensions	Code
Bread Tin	340gr (0.75 lb) (170 x 100 x 100mm)	1E4-001
Bread Tin	450gr (1 lb) (235 x 105 x 100mm)	1E4-002
Bread Tin	680gr (1.5 lb) (265 x 110 x 105mm)	1E4-003
Bread Tin	900gr (2 lb) (295 x 115 x 105mm)	1E4-004
French Stick Tins		1E4-006
Lids For Bread Tins		1E4-007
Loaf Pan	75mm x 47mm	2UBC5508
Loaf Pan	100mm x 57mm	2UBC5510
Loaf Pan	137mm x 70mm	2UBC5514
Loaf Pan	200mm x 100mm	2UBC5520
Loaf Pan	250mm x 110mm	2UBC5525
Loaf Pan	300mm x 110mm	2UBC5530

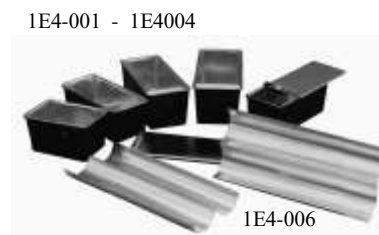

BREAD PANS

Description	Dimensions	Code
3 per set BR/PG 340g	403 x 189 x 102	L046/3-02
3 per set BR/PG 450g	400 x 252 x 97	L109/3-02
3 per set BR/PG 680g	402 x 285 x 106	L122B/3-02
3 per set BR/PG 680g	400 x 298 x 108	L158/3-02
3 per set BR/PG 900g	403 x 313 x 110	L059/3-02
2 per set BR/PG 900g		L193/2-02
2 per set BR/PG 1800g		L160/2-02
Bread Pans - Single	340g 450g 680g 900g 272x114x31 167x131x101 178x122x74 217x140x75 203x114x110	L046/1-01 L109/1-01 L122B/1-01 L059/1-01 V270/1-01 OML/1-01 FHS/1-01 FHL/1-01 T203/1-01



BREAD PAN LIDS

Description	Dimensions	Code
3 per set slotted:		
C109/3	410 x 260 x 25mm	LC109/3
C122B/3	410 x 293 x 25mm	LC122B/3
C158/3	410 x 306 x 25mm	LC158/3
3 per set - no slots:		
C59/3	410 x 321 x 25mm	LC59/3
C193/2	325 x 293 x 25mm	LC193/2



BREAD PAN TROLLEYS

Description	Dimensions	Code
2 sets long	63 x 43 cm	RBPT2
3 sets long	90 x 43 cm	RBPT3

BREAD PANS & ACCESSORIES

ASSORTED PANS

Description	Dimensions	Code
Continental Vienna Pans (set of 5)	680grams 400 x 737mm	LCV330/5-02
Continental Vienna Pans (set of 4)	680grams 400 x 737mm	LCV330/4
Vienna Pans Panglazed (set of 3)	450grams 400 x 297mm	LV270/3-02
Vienna Pans Panglazed (set of 3)	450grams 400 x 303mm	LV286/3-02
Farmhouse Loaf Small (set of 4)	450grams 395 x 283mm	LFHS/4-02
Farmhouse Loaf Large (set of 2)	680grams 400 x 227mm	LFHL/2-02
Farmhouse Loaf Small Single		LFHS/1-02
Farmhouse Loaf Large Single	680grams	LFHL/1-02
Corrugated Tank Loaf Pans:		
Set of 3	450 grams 200mm	LT203/3-02
Set of 3	450 grams 225mm	LT229/3-02
Set of 3	680 grams 275mm	LT280/3-02
Cob/Boston/Sponge Pans (set of 8)	400 x 778mm	LCBS178/8-02



LV270/3-02



LCBS178/8-02



CPEEL



LT203/3-02



LFHS/4-02



LFHL/1-02

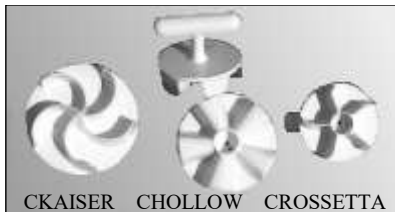

CKAISER CHOLLOW CROSSETTA



BREAD PEEL

Description	Dimensions	Code
Heavy duty cast Aluminum bread peel Affix your own length handle	53 x 25 cm	CPEEL

BREAD ROLL DOUGH STAMPS

Description	Dimensions	Code
Heavy Duty Cast Aluminium		
Kaiser	120mm	CKAISER
Hollow	100mm	CHOLLOW
Rossetta	80mm	CROSSETTA

BUN DIVIDER

Description	Dimensions	Code
14 Piece Hand Bun Divider		P07BD

BUN DIVIDER PLATES

Description	Dimensions	Code
Bun divider plates are available to suit many different machines. Simply bring in your old plate so we can match it up.		

BAKING TINS

SQUARE CAKE TINS

Description	Dimensions	Code
Square Cake Tins	All Tins are 80mm (3") in height	
	100mm (4")	1E1-001
	125mm (5")	1E1-002
	150mm (6")	1E1-003
	175mm (7")	1E1-004
	200mm (8")	1E1-005
	225mm (9")	1E1-006
	250mm (10")	1E1-007
	275mm (11")	1E1-008
	300mm (12")	1E1-009
	325mm (13")	1E1-010
	350mm (14")	1E1-011
	375mm (15")	1E1-012



ALUMINIUM SQUARE CAKE PANS

Description	Dimensions	Code
Square Cake Pan	200 x 75mm 225 x 75mm 250 x 75mm	CPSQ200/75AL CPSQ225/75AL CPSQ250/75AL

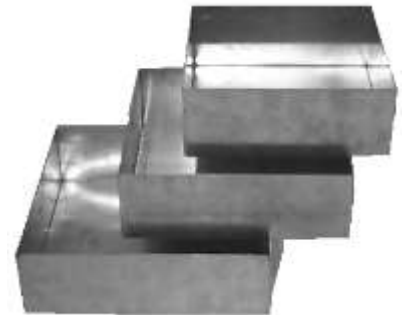

ROUND CAKE TINS

Description	Dimensions	Code
Round Cake Tins	87mm (3.5")	1E2-001
	115mm (4.5")	1E2-002
	125mm (5")	1E2-003
	151mm (6")	1E2-004
	176mm (7")	1E2-005
	203mm (8")	1E2-006
	218mm (9")	1E2-007
	245mm (10")	1E2-008
	273mm (11")	1E2-009
	295mm (12")	1E2-010
	325mm (13")	1E2-011
	350mm (14")	1E2-012
	375mm (15")	1E2-013
	400mm (16")	1E2-014



ALUMINIUM ROUND CAKE PANS

Description	Dimensions	Code
Round Cake Pan	10 x 1.5in	CPR10/1.5AL
	10 x 3in	CPR10/3AL
	11 x 3in	CPR11/3AL
	12 x 3in	CPR12/3AL
	6 x 1.5in	CPR6/1.5AL
	6 x 3in	CPR6/3AL
	7 x 1.5in	CPR7/1.5AL
	7 x 2in	CPR7/2AL
	7 x 3in	CPR7/3AL
	8 x 1.5in	CPR8/1.5AL
	9 1.5in	CPR9/1.5AL
	9 x 3in	CPR9/3AL

(Some sizes can be made to order please call for quote)



BAKING TINS

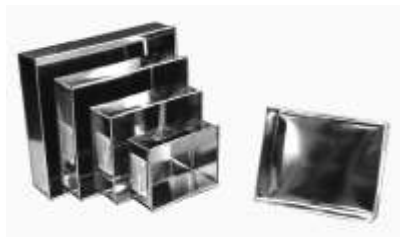

RECTANGULAR CAKE TINS

Description	Dimensions	Code
Complete Set (No's. 1-4)		1E6-025
No. 1	175mm x 125mm	1E6-026
No. 2	225mm x 175mm	1E6-027
No. 3	275mm x 225mm	1E6-028
No. 4	325mm x 275mm	1E6-029

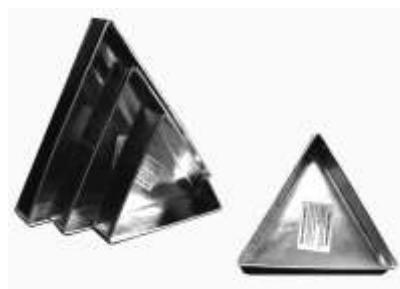

TRIANGULAR CAKE TINS (Equilateral Triangles)

Description	Dimensions	Code
Complete Set (No's. 1-3)		1E6-035
No. 1	225mm sides	1E6-036
No. 2	300mm sides	1E6-037
No. 3	375mm sides	1E6-038



DIAMOND CAKE TINS

Description	Dimensions	Code
Set: No's. 1 - 4		1E6-007
Set: No's. 1 - 3		1E6-008
No. 1	150mm sides x 250 long	1E6-009
No. 2	200mm sides x 325 long	1E6-010
No. 3	250mm sides x 425 long	1E6-011
No. 4	320mm sides x 545 long	1E6-012
No. 5	390mm sides x 650 long	1E17-002



FLAT TOP DIAMOND TINS

Description	Dimensions	Code
Complete Set (No's. 1-3)		1E6-030
No. 1	225 long x 125 wide	1E6-031
No. 2	290 long x 170 wide	1E6-032
No. 3	375 long x 230 wide	1E5-033



CORNER CUT RECTANGULAR TINS

Description	Dimensions	Code
Set: No's. 1 - 4		1E6-001
Set: No's. 1 - 3		1E6-002
No. 1	235 x 145mm	1E6-003
No. 2	285 x 200mm	1E6-004
No. 3	330 x 265mm	1E6-005
No. 4	375 x 320mm	1E6-006
No. 5	425 x 380mm	1E17-001

BAKING TINS

STAR CAKE TIN		
Description	Dimensions	Code
Star of David	355mm Point to Point 410mm Point to Point	1E9-009 1E9-010

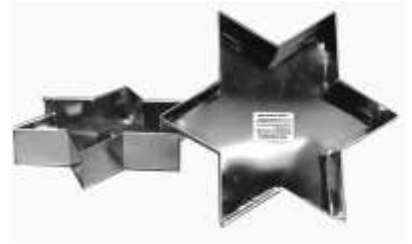

HEXAGONAL CAKE TINS		
Description	Dimensions	Code
No.1	150mm side to side	1E6-015
No.2	200mm side to side	1E6-016
No.3	250mm side to side	1E6-017
No.4	300mm side to side	1E6-018
No.5	350mm side to side	1E6-019



OCTAGONAL CAKE TINS		
Description	Dimensions	Code
No.1	175mm side to side	1E6-021
No.2	225mm side to side	1E6-022
No.3	275mm side to side	1E6-023
No.4	315mm side to side	1E6-024
No.5	370mm side to side	1E6-025

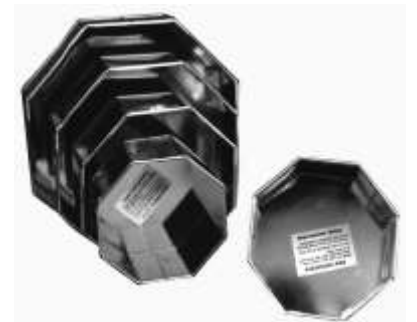

ROUND LOG TINS		
Description	Dimensions	Code
No.1	290 long x 120 wide	
No.2	345 long x 150 wide	
No.3	395 long x 175 wide	



OVAL CAKE TINS		
Description	Dimensions	Code
No.1	180 long x 120 wide	1E7-031
No.2	235 long x 160 wide	1E7-032
No.3	250 long x 180 wide	1E7-033
No.4	315 long x 230 wide	1E7-034
No.5	360 long x 280 wide	1E7-035
No.6	390 long x 315 wide	1E7-036



ABSTRACT HEART TIN		
Description	Dimensions	Code
Abstract Heart Tin	150mm 190mm 235mm 275mm	1E7-0201 1E7-0202 1E7-0203 1E7-0204



BAKING TINS

3 LEAF CLOVER CAKE TINS

Description	Dimensions	Code
No.1	160mm across	1E8-002
No.2	200mm across	
No.3	260mm across	
No.4	310mm across	
No.5	370mm across	

4 LEAF CLOVER CAKE TINS

Description	Dimensions	Code
Set: No's. 1-3		1E8-008
No.1	165mm across	1E8-009
No.2	225mm across	1E8-010
No.3	280mm across	1E8-011
No.4	330mm across	1E8-012

5 PETAL CAKE TINS

Description	Dimensions	Code
No.1	200mm across	
No.2	240mm across	
No.3	280mm across	
No.4	320mm across	

6 PETAL CAKE TINS

Description	Dimensions	Code
No.1	180mm across	1E8-022
No.2	230mm across	1E8-023
No.3	280mm across	1E8-024
No.4	360mm across	1E8-025

8 PETAL CAKE TINS

Description	Dimensions	Code
No.1	170mm across	
No.2	230mm across	
No.3	295mm across	
No.4	340mm across	

HEART GATEAU PAN

Description	Dimensions	Code
Heart Gateau Pan	18cm (7") 28cm (11")	1F3056 1F3055



BAKING TINS

4 SCALLOPED OVAL CAKE TINS

Description	Dimensions	Code
No.1	200mm long x 135 wide	1E8-044
No.2	260mm long x 185 wide	1E8-045
No.3	325mm long x 235 wide	1E8-046
No.4	400mm long x 280 wide	1E8-047
No.5	480mm long x 330 wide	



6 SCALLOPED OVAL CAKE TINS

Description	Dimensions	Code
No.1	210mm long x 145 wide	
No.2	270mm long x 185 wide	
No.3	320mm long x 240 wide	
No.4	370mm long x 290 wide	



8 SCALLOPED OVAL CAKE TINS

Description	Dimensions	Code
No.1	200mm long x 130 wide	
No.2	260mm long x 185 wide	
No.3	315mm long x 230 wide	
No.4	370mm long x 280 wide	



ALUMINIUM CAKE RINGS

Description	Dimensions	Code
Cake Rings	7"	C11SRING1
	8"	C11SRING2

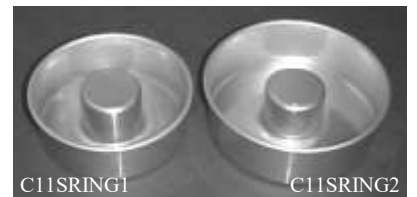

REGULAR AND BAR SHAPED TINS

Description	Dimensions	Code
Bar Tins	203 x 76 x 76mm (8" x 3" x 3") 200 x 80 x 50mm (8" x 3" x 2") 225 x 75 x 75mm (9" x 3" x 3")	1E-BARTIN 1E3-008 1E3-001
Log Tin	325 x 80 x 80mm (13" x 3.25" x 3.25")	1E3-009
Orange Cake Tin	225 x 150mm (9" x 6")	1E3-003
Lamington Tin	300 x 200 x 37mm (12" x 8" x 1.5")	1E3-004
Anglo American	254 x 178 x 51mm (10" x 7" x 2")	1E3-005
Ballerina	343 x 177 x 63mm (13.5" x 7" x 2.5")	1E3-006

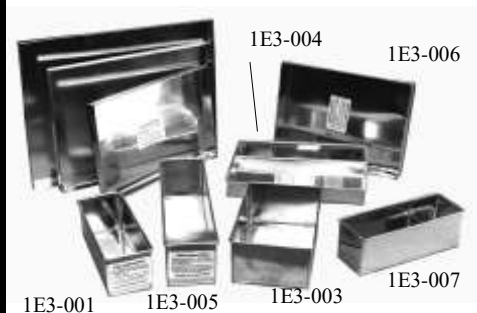

BAKING TINS



1E3-005



1F3006

1F3008

1F3012



Pudding

Dariol

Fluted Dariol



1F3012

1F2905

2UBC5210S



1R331121



1R332271

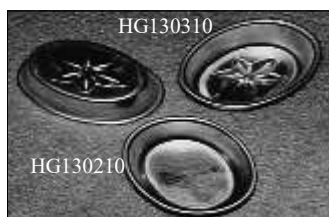

HG130310

HG130210



HG124050

HG124050



1B02KW607



1B02KW575

SWISS ROLL TINS

Description	Dimensions	Code
Swiss Roll Tins	300 x 200mm (12" x 8") 350 x 250mm (14" x 10") 400 x 300mm (16" x 12")	1E3-005 1E3-006 1E3-007

SPRINGFORM CAKE PANS

Description	Dimensions	Code
Springform Cake Pan (Tin)	18cm 20cm 22cm 24cm 26cm 28cm 30cm	1F3002 1F3003 1F3004 1F3005 1F3006 1F3007
S/S Heavy Duty	24cm 26cm 28cm	Q68024 Q68026 Q60828
Fluted Base	24cm 26cm	1F3012 1F3013
Non-Stick	18cm 20cm 24cm 26cm 28cm	1F2900 1F2905 1F2901 1F2902 1F2907
Heart Shape	W=11.5cm x H=11 cm	2UBC5210S

MOULDS

Description	Dimensions	Code
Pudding Mould	65 x 35mm 75 x 42mm 67 x 56mm	
Dariol Mould	67 x 55mm	
Fluted Dariol Mould	50 x 60mm	
"Trois Freres" Ring Mold (Non stick)	H-40mm H-45mm H-60mm H-80mm	
Savarin Molds - Tin	80mm 120mm 240mm	HG124030 HG124034 HG124050
- Aluminium	240mm 140mm 200mm 260mm 300mm	3A2951 QPD7060-14 QPD7060-20 QPD7060-26 QPD7060-30
Kuglehopf Molds - Non-Stick	70mm 100mm 120mm	1R331121 1R331123 1R331125
- Aluminium	18cm 14cm	1B02KW607 1B02KW606
- American	18cm	1B02KW575
Friand (oval) Mold - Tin	75mm	HG130210
- Aluminium	75mm	3A2892
- Star Base (Tin)	75mm	HG130310
- Star Base (Al)	75mm	3A2893
- 9 cup (Star)	370 x 260mm	1F94635
- 9 cup (Plain)	370 x 260mm	X70673N/S

BAKING TINS

FLUTED CAKE/QUICHE/TART PANS

Description	Dimensions (mm)		Code	
	Base	Height		
Cake - Loose Base	100	30	Q64010	
	180	40	Q64018	
	200	45	Q64020	
	230	45	Q64023	
	250	47	Q64025	
	280	50	Q64028	
	Quiche - Loose Base	80	18	2UBQ12608
100		20	2UBQ12610	
120		15	Q64112	
120		20	2UBQ12612	
140		25	2QGO126412	
150		22	2UBQ12615	
150		40	2QGO124820	
180		22	Q64118	
200		20	2UBQ12620	
200		20	Q64120	
200		25	2QGO126420	
200		35	2QGO126620	
200		45	2QGO124830	
220		25	2QGO126422	
220		35	2QGO126622	
240		20	Q64124	
240		25	2QGO126430	
240		25		
240		35	2QGO126630	
260		25	2QGO126432	
260		35	2QGO126632	
270		50	2UBQ25627	
280		25	2QGO126440	
280		25	Q64128	
280		35	2QGO126640	
300		25	2QGO126442	
320		25	Q64132	
320	35	2QGO126650		
Quiche (Rectangular) - Loose Base	300	210	Q64040	
Tartlette - Plain Round	70		1R63016	
	90		1R63031	
Brioche Tin - 12 ribs	60		Q64201	
	70		Q64203	
	- 10 ribs	75		Q64204
		80		Q64205
	- 14 ribs	90		Q64206
		55 (100 at top)	38	2Q193760
	55 (110 at top)	42	2Q193770	
	240		1R62822	

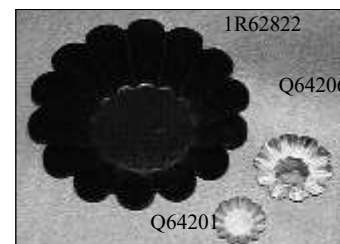
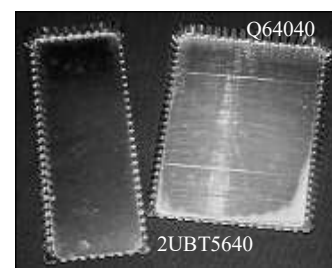
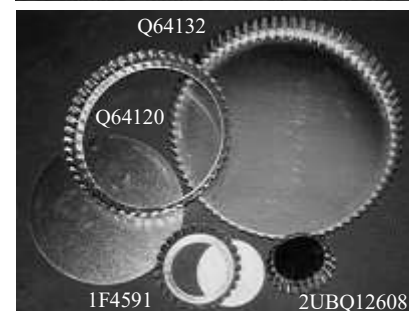
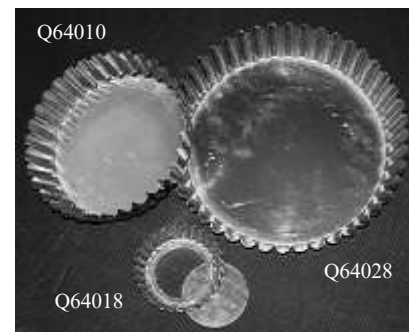

Tart - Loose Base	Length 355	Width 128	Height 25	2UBT5640
Mini Rect Tart Pan	120	60	20	3A2876



UPRIGHT BELL/DOLLY VARDEN CAKE TIN/BAKING CUPS

Description	Dimensions	Code
Upright bell Tin No.1	130x105mm	1E9-015
Upright bell Tin No.2	185x150mm	1E9-016
Dolly Varden small	145x115mm	1E9-007
Dolly Varden large	195x155mm	1E9-008



BAKING TINS

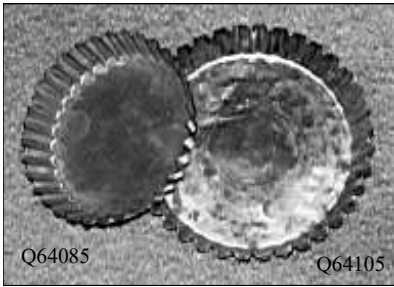

GENOIS TINS

Description	Dimensions	Code
Genois Tin	85mm 95mm 105mm	Q64085 Q64095 Q64105



CAKE RINGS

Description
* Standard sizes in stock from 6-10in
* Any size made to order



KUGELHOPF/MISCELLANEOUS PANS

Description	Dimensions	Code
Kugelhopf Pan	180mm 220mm 240mm 240mm	1F2908 3A2942 3A2975
Bundt Pan	260 x 100mm	3A2938
Christmas Wreath Pan	240mm	
Angel Cake Pan		3A2853
pudding Steamer	1 Litre	3A2923
pudding Steamer	2 Litre	3A2924
pudding Steamer with Ring	2 Litre	3A2922
Charlotte Pan	100mm	CHARLOT10



NUT LOAF TIN

Description	Dimensions	Code
Nut Loaf Tin Double Lid	75x150mm 75x176mm 80x200mm	PNT1 PNT2 3A2953

BAKING TINS

SELF CUTTING PIE TIN DIMENSIONS

Tin No.	A	B	C	D	E	Vol (app)	Foils
Round							
1ZP1	114	104	69	25	21	170g	C2511
1ZP1F/P2	118	104	69	25	21	170g	A167
1ZP3	114	104	75	20	16	150g	
1ZP5	103	94	63	25	21	120g	
1ZP6*	86	81	56	21	18	88g	
1ZP6	87	82	55	21	17	84g	
1ZP8	75	70	43	20	17	65g	
1ZP9	75	70	45	14	11	45g	
1ZRB	126	112	91	31	26	300g	
1ZR1*	106	98	79	34	30	200g	
1ZR1WF*	112	98	79	36	30	220g	
1ZR2*	106	98	82	30	24	175g	
1ZR2	106	98	78	30	26	195g	K338
1ZR1F	112.5	100	77	35	31	230g	
1ZR2F	112.5	100	80	30	26	210g	K339 & K340
1ZR2WF*	112	98	82	30	24	175g	
1ZR5	87	80	65	25	21	106g	
1ZR7	114	104	90	24	20	190g	
1ZR7F	117.5	102	87	24	20	180g	K347
1ZR10	65	60	40	25	21	65g	
1ZR12	58	53	33	23	20	40g	
1ZFP8*	203	174	144	22	17		
1ZFP9*	228	208	170	26	21		

***These tins can be supplied with Rolled Edge**

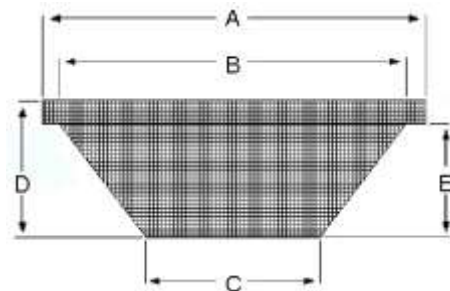

BAKING TINS

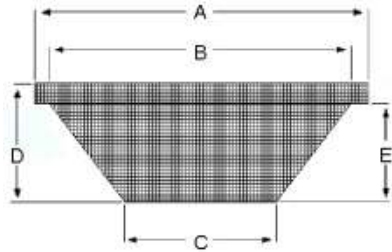

Tin No.	A	B	C	D	E	Vol (app)	Foils
Square							
1ZS1	107	97	86	26	22	200g	
1ZS3	107	97	68	25	19	180g	
Oval							
1ZO2	98	90	78	23	19	180g	
	128	120	108				
1ZNZ	103	87	61	30	25	180g	
	130	113	86				
1E10-003	114	90	68	20	18		
	140	117	95	20	18		
Oblong							
1ZOL Traveller	170	158	146	22	17	180g	
	70	58	44				
1ZO1	84	74	64	28	24	180g	
	126	116	104				
1ZO3	54	48	38	24	21	56g	
	70	63	54				
Rolled Edge							
PR202	69	60	45	14	14	35g	
PR204	65	57	33	9	9	30g	
PR206(3S)	75	70	45	10	10	40g	
PR207(3D)	78	71	45	17	17	45g	
PR212	116	110	72	18	18	140g	
PR213	115	106	65	25	25	150g	
PR214	104	94	62	22	22	130g	
1E10-001	125	110	92	30	26	125g	
2UBP51312	125	112	78	32	30		
1E10-005*	77	65	30	25	20		
Savoury Boat							
1Z219	115	42			15	25g	

BAKING TINS

NUMBER CAKE TINS

Description	Dimensions	Code
Number 1		1E5-012
Number 2		1E5-013
Number 4		1E5-014
Number 5		1E5-015
Number 6/9		1E5-016
Number 7		1E5-017
Number 3/8		1E5-018
Number 0		1E5-019



KEY CAKE TINS

Description	Dimensions	Code
Latch Key - Small	405mm long	1E5-005
Latch Key - Large	450mm long	
Yale Key - Small	400mm long	1E5-006
Yale Key - Large	450mm long	1E5-008
Yale Key - Fancy	450mm long	



HORSE SHOE CAKE TINS

Description	Dimensions	Code
No. 1	200mm across	1E7-021
No. 2	250mm across	1E7-022
No. 3	325mm across	1E7-023



HEART CAKE TINS

Description	Dimensions	Code
No. 1	140mm across	1E7-014
No. 2	185mm across	1E7-015
No. 3	230mm across	1E7-016
No. 4	280mm across	1E7-017
No. 5	330mm	1E7-018
No. 6	375mm	1E7-019
Double Heart	355mm wide x 230mm top to bottom	1E7-020



MINIATURE CAKE TINS

Description	Dimensions	Code
Hexagon	100mm across x 65 deep	1E16-001
Octagon	100mm across x 65 deep	1E16-002
Oval	100mm x 75 x 65 deep	1E16-003
Heart	100mm across x 65 deep	1E16-004



- ALSO AVAILABLE IN NON-STICK -

BAKING TINS



BELL CAKE TINS		
Description	Dimensions	Code
No. 1	190mm across x 190 high	
No. 2	245mm across x 245 high	
No. 3	305mm across x 305 high	
No. 4	360mm across x 360 high	



MAP OF AUSTRALIA CAKE TIN		
Description	Dimensions	Code
Small	280mm wide x 270mm	1E9-001
Large	420mm wide x 405mm	1E9-002



OPEN BOOK & FLAG CAKE TINS		
Description	Dimensions	Code
Flag Cake	300mm across body x 320mm pole	1E9-040
Open Book Small	270x205mm	1E9-004
Open Book Large	370mm wide x 255mm top to bottom	1E9-005



DOLLY VARDEN & UPRIGHT BELLS		
Description	Dimensions	Code
Dolly Varden Small	270mm x 205mm	1E9-004
Dolly Varden Large	370mm wide x 255mm top to bottom	1E9-005
Upright Bells		
No. 1	130mm dia. x 105 high	1E9-015
No. 2	185mm dia. x 150 high	1E9-016
No. 3	235mm dia. x 195 high	1E9-017



FAN CAKE TINS		
Description	Dimensions	Code
No. 1	190mm sides	
No. 2	250mm sides	
No. 3	310mm sides	



COMMA CAKE TINS		
Description	Dimensions	Code
No. 1	260mm long x 185 wide	1E9-027
No. 2	325mm long x 225 wide	1E9-028
No. 3	380mm long x 260 wide	1E9-029

BAKING TINS

CRESCENT CAKE TINS

Description	Dimensions	Code
No. 1	260mm overall x 185mm at widest point	
No. 2	300mm overall x 150mm at widest point	
No. 3	340mm overall x 190mm at widest point	



NOVELTY CAKE TINS

Description	Dimensions	Code
Cruiser pan	11x7mm	1C21052043
Cuddly Bear pan 3D		1C21050603
Enchanted Castle pan		1C21052031
Flower Pot	345 x 250mm	1C21052030
Football Pan	300 x 200mm	1C21056504
Gingerbread Boy	370 x 260mm	1C21053313
Guitar pan		1C21050570
Holiday House 3D	200 x 215 x 75mm	1C21053311
Huggable Bear	325 x 300mm	1C21054943
Juggling Clown pan		1C21050572
Lion	360 x 315mm	1C21052095
Little Locomotive		1C21056500
Party Saurus	395 x 295mm	1C21051280
Race Car Pan	325 x 250mm	1C21051350
Snowman pan		1C21050803
Train Pan 3D		1C21052861
Treelife pan		1C21050425
Dinosaur	370mm	2UBC5955
Horse Cake Pan	400mm	2UBC5953
Puppy Pan	330mm	2UBC5958
Teddy Bear Cake Pan		2UBC5950
Miniature Tins		
-Tray of Six		
Mini Embossed Heart	Overall-355 x 255mm; Each-300 x 85mm	1C21058255
Mini Dinosaurs	Overall-350 x 270mm; Each-100 x 70mm	1C21059331
Huggable Bears	Overall- 370 x 290mm; Each-115 x 115mm	1C21056500
Baby Bears	Overall-350 x 265mm; Each -100mm	2UBC5962T
-Singles		
Baby Bear	100mm	2UBC5952
Heart - Tin	100mm	2UBC5310
- Non-Stick	100mm	3A2995
Fancy Heart (Al)	100mm	1C21051105
Viennese Swirl (Al)	110mm	1C21051110
Volkswagon	300mm	3A2960
Rabbit Mould	130mm	3A2904



BAKING TINS

NOVELTY CAKE TINS (Christmas)

Description	Dimensions	Code
Christmas Treeliteful	390 x 290mm	1C2105-A-425
Xmas Bear	325 x 275mm	1C2105-A-4432
Santa Claus With List	350 x 300mm	1C21053323
Merry Santa	310 x 260mm	1C21059421
Treeliteful Pan	390 x 290mm	1C21053323
Santa Cake Pan	400mm	2UBC5956
3D Xmas Tree Pan	220 x 240mm	1C21050425
Xmas Tree 3D		1C21050750
Xmas Tree Cake Pan	320mm 280mm	3A2934 3A2939



SANTA CAKE TINS

Description	Dimensions	Code
Santa Tins Set of 2	120 x 90 x 65mm / 40 x 90 x 53mm	3A4398-2



CROQUEMBOUCHE CONES

Description	Dimensions	Code
Aluminum	Height: 340mm x Diameter: 230mm	1B01KW623
Aluminum	Height: 460mm x Diameter: 255mm	1ECROQS
S/S	Height: 610mm x Diameter: 320mm	1ECROQL



DISPOSABLE BAKEWARE MOULDS (Sell product straight from oven)

Description	Dimensions	Description	Code
Round Large	200 x 60mm	480 pc	2ACAK1
Round Small	186 x 70mm	480 pc	2ACAK2
Heart Mini	133 x 35mm	300 pc	2AHEA1
Loaf Large	250 x 95 x 65mm	120 pc	2ALOAL
Loaf Small	195 x 83 x 50mm	200 pc	2ALOAS
Muffin	64 x 45mm	500 pc	2AMUF1
Ring	213 x 60mm	450 pc	2ARIN1
Star Large	286 x 70mm	600 pc	2ASTA1
Star Mini	133 x 35mm	300 pc	2ASTA3
Tart Large	249 x 45mm	420 pc	2ATARL
Tart Small	192 x 35mm	600 pc	2ATARS
Christmas Tree	335 x 242 x 60mm	400 pc	2AXMAS



PIZZA WARE

PIZZA TRAYS - Solid

Description	Dimensions	Code
Pizza Tray Aluminum	160mm / 6"	2CAPT6
	200mm / 8"	2CAPT8
	230mm / 9"	2CAPT9
	250mm / 10"	2CAPT10
	280mm / 11"	2CAPT11
	300mm / 12"	2CAPT12
	330mm / 13"	2CAPT13
	350mm / 14"	2CAPT14
	380mm / 15"	2CAPT15
	400mm / 16"	2CAPT16
	425mm / 17"	2CAPT17
	475mm / 18"	2CAPT18
Pizza Tray Aluminised White Steel	160mm / 6"	2CZPT6
	180mm / 7"	2CZPT7
	200mm / 8"	2CZPT8
	230mm / 9"	2CZPT9
	250mm / 10"	2CZPT10
	280mm / 11"	2CZPT11
	300mm / 12"	2CZPT12
	330mm / 13"	2CZPT13
	350mm / 14"	2CZPT14
	380mm / 15"	2CZPT15
	400mm / 16"	2CZPT16
	475mm / 18"	2CZPT18
Party tray	600mm / 24"	2CZPT24
Mesh screen pizza trays	Sizes available from 8" - 15"	



2CBPT11



2CMESH

PIZZA TRAYS PERFORATED

Description	Dimensions	Code
Pizza Tray (aluminium)	8"	2CAPTH8
	9"	2CAPTH9
	10"	2CAPTH10
	11"	2CAPTH11
	12"	2CAPTH12
	13"	2CAPTH13
	14"	2CAPTH14
	15"	2CAPTH15
	16"	2CAPTH15
	18"	2CAPTH18
Black Steel Perforated	Sizes available from 8" - 18"	



2CAPTH9

WOOD PIZZA SERVING TRAYS

Description	Dimensions	Code
Serving Tray Wood	330mm / 13" - Mahogany	Q04230
	370mm / 15" - Mahogany	Q04234
	435mm / 17" - Mahogany	Q04243



Q04230

PIZZA ACCESSORIES

Description	Dimensions	Code
Alum Flat Saucing Rings	9, 11, 12, 13, 15inch	2CART
Alum Deep Saucing Rings	9, 11, 12, 13, 15inch	2CARD
Aluminium Cover	Sizes from 6 - 18inch	2CSPL

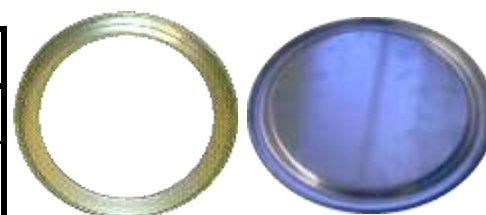

2CAR11

PIZZA WARE

PIZZA ACCESSORIES

Description	Dimensions	Code
Pizza Pan Gripper - Deep Dish	90mm	Q06275
Pizza Cutter S/S Plastic Handle	100mm	Q06285
Pizza Cutter S/S Aluminium Handle	95mm	1Y18053
Dexter Russell Pizza Cutter made in (USA)	4"	1Y19893
Pizza Cutter S/S Wheel/HD Alum	100mm	I30285
Pizza Rocker Cutter	20in	AM18053
Pizza Peel - Aluminium Wood Hdl	31x33cm / length 172cm	Q06201
Pizza Peel - Aluminium Hdl	25x17.2cm / length 152cm	IQB4032
Pizza Peel - S/S H/D	33 x 31cm / length 130cm	1R118006
Pizza Peel - S/S Round	53 x 53 cm / length 110cm	I30296
Pizza Bags: - Double Triple	2 rack 3 rack	2CPBAG-D 2CPBAG-T
Pizza rack, 18 trays chrome	360 x 300/ h-720mm	I66000
Pizza rack wall mounted, 18 trays	300 x 270/ h-680mm	I66001
Pizza rack, 18 trays chrome (Australian Made)	300 x 510/ h-720mm	K1415
Wood Pizza Paddle	340 x 315mm	3A4406-1
Pizza Stone (Ceramic)	33cm 38cm	3A4403 3A4402-1

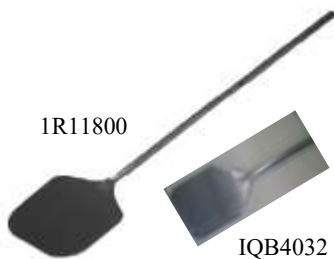

CROCKERY



Q311-090 Q311-094



Q311-030



Q500-100



Q500-050



Q330-088



2BGP13

Q330-105



I68028



Q330-105



Q330-050



I70940



I70935



Q06679



Q06906-S

ROYAL GLASSWARE– range of high quality products		
Description	Dimensions	Code
Baviera Bear Glass (6) Carton	265 ml 380 ml 510 ml	Q311-090 Q311-092 Q311-094
Stern-Bear (6) Carton	260 ml 510 ml	Q311-030 Q311-035
Orleans Beer (6) Carton	280 ml 360 ml	Q500-100 Q500-101
Tumbler (6) Carton	90 ml 130 ml 160 ml	Q500-050 Q500-051 Q500-052
Sundae (6) Carton	380 ml	Q330-088
Genziana Dessert (6) Carton	245 ml 325 ml	Q330-050 Q330-070
Jar - cookie	4.00ltr 2.50ltr	I68028 I68030
Glass Pitcher	1.30ltr	2BGP13
Moresca Water Bottle	1.00ltr	Q330-105
Single Glass Brush	185x100mm	I70935
Triple Glass Brush 3 in 1	185x185mm	I70940
Salt & Pepper Shaker	55mm	Q06679
Rack for salt/paper/sugar packet	155mm	Q06906-S

CROCKERY

ROYAL VITROCERAM - range of high quality products.

Description	Dimensions	Code
Oval Serving Plater / 2 Different Sizes	240x170mm 290x200mm	Q901609 Q901611
Square Serving Plater	175x175mm	Q96551
Sugar Pack Holder	95x70mm	Q901328
Teapot	75mm Height 82mm Height	Q909120 Q909130
Rice Bowl St Sided	110mm	Q901544



Q901609

Q901328



Q909120

Q901544

VITROCERAM - super vitrified plain white hotelware with narrow rim. Chip resistant, oven and microwave proof, dishwasher safe, excellent heat retention.

Description	Dimensions	Code
Plates		
Round Plate with 20mm Rim	160mm 180mm	Q902606 Q902607
Round Plate with 25mm Rim	230mm 250mm 300mm	Q902609 Q902610 Q902612
Bowls		
Rice Bowl Straight Sided	110mm	Q901544
Desert/Fruit Bowl	135mm	Q900130
Soup Bowl	170mm	Q000140
Soup/Pasta Bowl	230mm	Q900146
Salt and Pepper Shakers (tower shape):		
Salt Shaker		Q900151
Pepper Shaker		Q900161
Cups, Saucers and Mugs		
Stackable Espresso Cup	90ml	Q900008
Saucer	115mm	Q900018
Cappuccino Cup (fits saucer Q900020)	230ml	Q900006
Tea & Coffee Accessories		
Creamer	170ml	Q900115
Sugar Bowl with Cover	285ml	Q900125
Sugar Pack Holder	95x65x65mm	Q901328
Teapots:		
3 cup	500ml	Q909120
4 cup	800ml	Q909130
Sauce/Butter Dish	100mm	Q901004

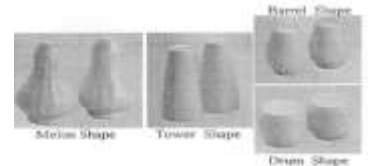

CROCKERY

ROYAL PORCELAIN CHELSEA - range of high quality products.

Description	Dimensions	Code
Plates		
Round Plate Rim Shape	160mm 180mm 210mm 240mm 260mm 280mm 300mm 315mm	Q94001 Q94002 Q94003 Q94004 Q94005 Q94006 Q94007 Q94008
Round Plate Raised Rim	168mm 180mm 200mm 230mm 255mm 270mm	Q94009 Q94010 Q94011 Q94012 Q94013 Q94014
Round Plate Coupe Shape	150mm 170mm 190mm 210mm 240mm 260mm	Q94015 Q94016 Q94017 Q94018 Q94019 Q94020
Bowls		
Soup Cup with Handles	275ml	Q94052
Salad Bowl	140mm 190mm 210mm	Q94053 Q94055 Q94056
Rim Shape		
Fruit Bowl	120mm	Q94024
Pasta/Soup Bowl	190mm 210mm 235mm 280mm 360mm	Q94031 Q94031 Q94032 Q94033 Q94038
Deep Round Bowl	360mm	Q94038
Coupe Shape		
Cereal Bowl	140mm	Q94025
Soup Bowl	170mm	Q94026
Pasta/Soup Bowl	185mm	Q94027
Pasta/Soup Bowl	210mm	Q94029
Oval Bowl	150mm 200mm 250mm	Q94035 Q94036 Q94037
Salt and Pepper Shakers		
Salt & Pepper shaker (tower) - Vitrocera	90mm H	Q900151 Q900161
Salt Shaker - Chelsea	50 x 60mm	Q94094
Pepper Shaker	50 x 60mm	Q94095
Salt Shaker	53 x 85mm	Q94096
Pepper Shaker	53 x 85mm	Q94097

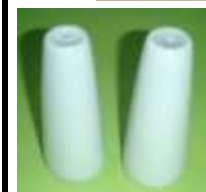

Q900151 Q900161



Q94094 Q94095 Q94096 Q94097

CROCKERY



ROYAL PORCELAIN CHELSEA - range of high quality products.

Description	Dimensions	Code
Ashtrays	100mm 110mm	Q94101 Q94102
Tea and Coffee Accessories		
Sugar Bowl with Cover Sugar Packet Holder	200ml	Q94078 Q94091
Creamer	120ml 200ml 100ml 190ml 300ml	Q94076 Q94077 Q94086 Q94087 Q94088
Teapot	400ml 800ml	Q94070 Q94071
Coffee Pot	300ml 500ml 1Lt	Q94072 Q94073 Q94074
Teapot with Lid	320ml 800ml	Q94080 Q94081
Coffee Pot with Lid	300ml 800ml 1Lt	Q94082 Q94083 Q94084
Cups and Saucers		
Espresso Cup Stackable	100ml	Q94040
Espresso Cup Tapered	75ml	Q94041
Saucer to suit Q94040, Q94041		Q94042
Espresso Cup Tall	100ml	Q94043
Saucer to suit Q94040, Q94043		Q94044
Coffee Cup Stackable	200ml	Q94045
Coffee Cup Stackable	200ml	Q94046
Coffee Cup Tapered	180ml	Q94047
Cappuccino Cup Tapered	230ml	Q94048
Teacup	200ml	Q94050
Saucer to suit Q94045/46/47/48/50		Q94049
Coffee Mug		Q94051

- A Q94040
- B Q94042
- C Q94041
- D Q94051
- E Q94044
- F Q94045
- G Q94047
- H Q94049
- I Q94048
- J Q94046
- K Q94050



STAINLESS STEEL CUPS & MUGS

INSULATED CUPS AND SAUCERS

Description	Dimensions	Code
Espresso Cup & Saucer set		Q 71570
Cappaccino Cup & Saucer set	230ml	Q 71572



COFFEE STENCILS

Description	Dimensions	Code
Coffee Stencils Set of 4	92 mm	3A3371-1



COFFEE MEASURING SPOON

Description	Dimensions	Code
S/S Coffee Measure Spoon	15 ml	3A3373



3A3373

STAINLESS STEEL POTS & BOWLS



TEA & COFFEE POTS

Description	Dimensions	Code
Cafeteria Style:		
Teapots	0.4Lt 0.5Lt 0.6Lt 1.0Lt 1.5Lt 2.2Lt 3.0Lt	Q7012 Q7016 Q7020 Q7032 Q7048 Q7050 Q7051
Coffee Pots	0.4Lt 0.5Lt 0.6Lt 1.0Lt 1.5Lt 2.2Lt	Q7061 Q7062 Q7063 Q7064 Q7065 Q7066
Regal Style:		
Teapots	0.37Lt 0.75Lt 1.0Lt 1.5Lt 2.0Lt	Q71813 Q71817 Q71835 Q71848 Q71870
Coffee Pots	0.37Lt 0.75Lt 1.0Lt 2.0Lt	Q71913 Q71924 Q71935 Q71970
Coffee Decanters:		
"Koffee" King with Stainless Steel Base	2.0Lt	Q7499
Coffee Decanter with hinged Cover	2.0Lt	Q7501

SUGAR BOWLS

Description	Dimensions	Code
Cafeteria Style:		
Sugar Bowl with hinged cover	300ml	Q7009
Regal Style:		
Sugar Bowl with cover	150ml 370ml	Q71905 Q71910

CREAMERS

Description	Dimensions	Code
Creamer (Cafeteria Style)	20ml 90ml 140ml 300ml	Q7001 Q7003 Q7005 Q7006
Bell Shaped Creamer (Cafeteria Style)	85ml 140ml 220ml	Q7103 Q7105 Q7108
Creamer (Regal Style)	150ml 370ml	Q71805 Q71810

STAINLESS STEEL JUGS

STAINLESS STEEL JUGS		
Description	Dimensions	Code
Elite Style Jug	150ml	Q71631
	230ml	Q71633
	350ml	Q71635
Frothing Jug	0.6Lt	Q07255
	1.0Lt	Q07256
	1.5Lt	Q07257
	2.0Lt	Q07258



STAINLESS WHISTLING KETTLE		
Description	Dimensions	Code
Glass dome lift of f lid S/S 1.9ltr Triple base & Bakelite stay cool handle, easy to clean	1.9 Lt	1F5135



1F5135

STAINLESS STEEL JUGS

WATER JUGS WITH ICE GUARD

Description	Dimensions	Code
Elite Style Water Jug	0.6Lt	Q71620
	1.0Lt	Q71622
	1.8Lt	Q71624
Regal Style Water Jug	2.5Lt	Q71880
Insulated Water Pitcher	0.6Lt	Q71652
	1.0Lt	Q71654
	1.4Lt	Q71656



CUTLERY



CUTLERY - AUSTWIND RANGE

Description	Dimensions	Code
Knives		
Table Knife	213mm	Q01072
Fish Knife	218mm	Q01069
Desert Knife	208mm	Q01071
Forks		
Table Fork	197mm	Q01060
Fish Fork	193mm	Q01068
Desert Fork	187mm	Q01052
Cake Fork	146mm	Q01058
Fruit Fork	140mm	Q01063
Oyster Fork	135mm	Q01062
Spoon		
Table Spoon	192mm	Q01059
Desert Spoon	180mm	Q01053
Soup Spoon	175mm	Q01054
Teaspoon	138mm	Q01055
Coffee Spoon	112mm	Q01051
Soda Spoon	187mm	Q01061
Fruit Spoon	133mm	Q01064
Icecream Spade	133mm	Q01065
Serving Utensils		
Pastry Server	240mm	Q01074



Q01065

CUTLERY - ATLANTIS RANGE

Description	Dimensions	Code
Knives		
Table Knife	217mm	Q01172
Desert Knife	205mm	Q01171
Steak knife	215mm	Q01173
Forks		
Table Fork	195mm	Q01160
Dessert Fork	180mm	Q01152
Cake Fork	145mm	Q01158
Fruit Fork	145mm	Q17363
Oyseter Fork	132mm	Q01162
Spoons		
Table Spoon	197mm	Q01159
Desert Spoon	178mm	Q01153
Soup Spoon	175mm	Q01154
Teaspoon	135mm	Q01155
Coffee Spoon	120mm	Q01151
Soda Spoon	187mm	Q01161
Fruit Spoon	137mm	Q01164



CUTLERY

CUTLERY - PRINCESS RANGE



Description	Dimensions	Code
Knives		
Table Knife	215mm	Q01272
Fish Knife	218mm	Q01269
Desert Knife	205mm	Q01271
Forks		
Table Fork	198mm	Q01260
Fish Fork	192mm	Q01268
Desert Fork	188mm	Q01252
Cake Fork	143mm	Q01258
Fruit Fork	137mm	Q01263
Oyster Fork	133mm	Q01262
Spoons		
Table Spoon	200mm	Q01259
Desert Spoon	186mm	Q01253
Soup Spoon	182mm	Q01254
Teaspoon	135mm	Q01255
Coffee Spoon	120mm	Q01251
Soda Spoon	190mm	Q01261
Fruit Spoon	137mm	Q01264
Serving Utensils		
Salad Fork	230mm	Q01243
Salad Serving Spoon	230mm	Q01244
Serving Fork	235mm	Q01247
Serving Spoon	225mm	Q01279
Pastry Server	283mm	Q01274

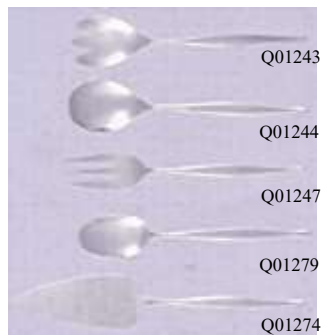

CUTLERY

CUTLERY - SORRENTO RANGE

Description	Dimensions	Code
Knives		
Table Knife	220mm	Q01872
Fish Knife	217mm	Q01869
Bread & Butter Knife	210mm	Q01870
Desert Knife	210mm	Q01871
Forks		
Table Fork	196mm	Q01860
Fish Fork	188mm	Q01868
Buffet Fork	178mm	Q01867
Dessert Fork	185mm	Q01852
Cake Fork	143mm	Q01858
Fruit Fork	138mm	Q01863
Oyseter Fork	130mm	Q01862
Spoons		
Table Spoon	196mm	Q01859
Desert Spoon	183mm	Q01853
Soup Spoon	178mm	Q01854
Teaspoon	133mm	Q01855
Coffee Spoon	113mm	Q01851
Soda Spoon	178mm	Q01854
Fruit Spoon	136mm	Q01864
Sugar Spoon	131mm	Q01857
Serving Utensils		
Salad Serving Fork	195mm	Q01843
Salad Serving Spoon	195mm	Q01844
Serving Spoon	215mm	Q01879
Soup Ladle	276mm	Q01886
Gravy/Sauce Ladle	172mm	Q01885
Pastry Server	268mm	Q01874



CUTLERY - ELITE RANGE (Satin finish)

Description	Dimensions	Code
Knives		
Table Knife	222mm	Q74772
Desert Knife	205mm	Q74771
Bread knife	172mm	Q74770
Forks		
Table Fork	195mm	Q74760
Dessert Fork	180mm	Q74752
Cake Fork	148mm	Q74758
Fruit Fork	138mm	Q17363
Oyseter Fork	138mm	Q74762
Spoons		
Table Spoon	205mm	Q74759
Desert Spoon	177mm	Q74753
Soup Spoon	170mm	Q74754
Teaspoon	142mm	Q74755
Coffee Spoon	125mm	Q74751
Soda Spoon	175mm	Q74761
Fruit Spoon	140mm	Q74764



CUTLERY

CUTLERY SETS - VICTORINOX	
Description	Code
POLYPROPYLENE HANDLES 24pc Cutlery Set Black Handles	A5.1333.24



A5.1333.24

CHOPSTICKS	
Description	Code
BAMBOO (10 pair pack)	3A1332
IRONWOOD (12 pair pack)	3A1341



CLEARING TROLLEYS

CLEARING TROLLEY		
Description	Dimensions	Code
Serving Trolley - 2 shelf S/S Extra Heavy duty, 2 Shelf, 5" castors (2 brakes & 2 swivel)	710 x 405 x 810mm	ITR-516
	810 x 455 x 855mm	ITR-518
	860 x 535 x 930mm	ITR-520
Serving Trolley - 3 shelf S/S Extra Heavy duty, 2 Shelf, 5" castors (2 brakes & 2 swivel)	710 x 405 x 810mm	ITR-526
	810 x 455 x 855mm	ITR-528
	860 x 535 x 930mm	ITR-530



ITR-526



ITR-526

PLASTIC UTILITY TROLLEY		
Description	Dimensions	Code
Plastic Utility Trolley	1060 x 480 x 1000mm	ITR-106



ITR-106

CUTLERY TROLLEY

CUTLERY TROLLEY		
Description	Dimensions	Code
3 Tier Cutlery Trolley Chrome Frame 50mm ball type twin wheel castors Supplied as a flat pack for easy transport Each tier accomodates a four compartment cutlery drawer (sold separately)	630L x 310W x 825H	K0335



TICKETS & PRICE TAGS

TICKETS & PRICE TAGS		
Description	Dimensions	Code
Spike Tag - printed	64 x 88mm (pack of 10)	3EFT2SPR
Spike Tag - printed	50 x 65mm (pack of 10)	3EFT1SPR
Spike Tag - Heat / R	65x90mm (pack of 10)	3EFT2SHR
Spike Tag - plain	76x127mm (pack of 10)	3EFT3S
Spike Tag - plain	64 x 88mm (pack of 10)	3EFT2S
Spike Tag - plain	50 x 65mm (pack of 10)	3EFT1S
White Tag	88 x 63mm (pack of 10)	3EFT2
White Tag	65 x 51mm (pack of 10)	3EFT1
White Tag	65x90mm (pack of 10)	3EFT2L
White Tag - Plain	85x195mm (pack of 5)	3EFT8
Ticket clip Steel Sp	25x95mm (pack of 10)	3ETHS
Ticket / Card Holder	20x50mm (pack of 10)	3ETTHE50
Angle Base - Variable	40x52mm (pack of 5)	3EVB50
Business Card Holder	30x100mm (pack of 1)	3ETHE50
Base Opaque - Square "Clear"	26x55mm (pack of 5)	3ESB
Basket Clip S/S	20x35mm (pack of 5)	3EBCSS
Sign: Bakers Choice	165 x 64mm (pack of 3)	3EDS3

(Some of the above available in black)

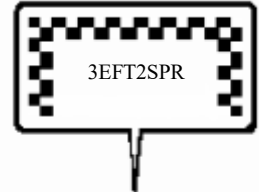
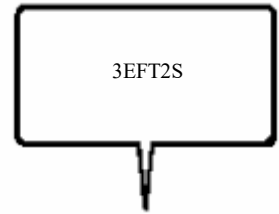

3EVB50

3ETHE50

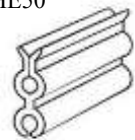

3EFT2L



3ETHS

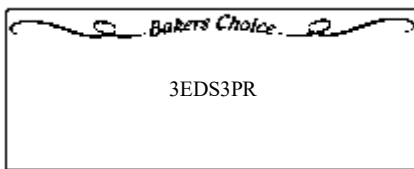

3EDS3PR

3ETB2W
A universal clip for "free standing" trays. Fits most styles & sizes.

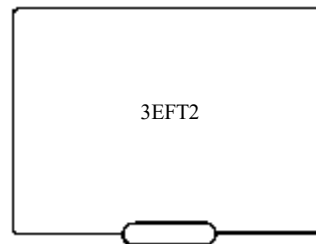

3EFT2

EXAMPLES OF HOW THE PIECES CAN FIT TOGETHER



3EFT2 + 3EHBW + 3EERW + 3ERBW

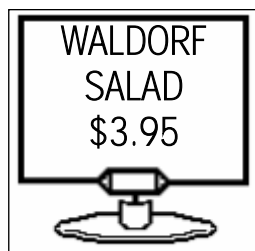

3EFT2 + 3EHBW + 3ERBW

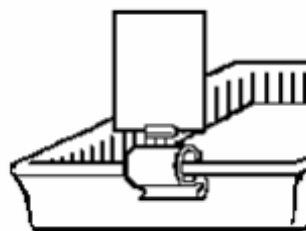

3EFT2 + 3EHBW + 3ETB2W



3EFT2 + 3EHBW + 3ETB2W

TICKETS & PRICE TAGS

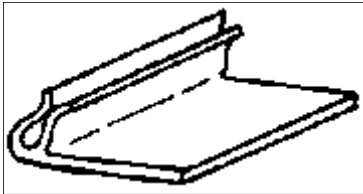

3EFB50

Ideal for the smaller laminated or display card on flat surfaces.

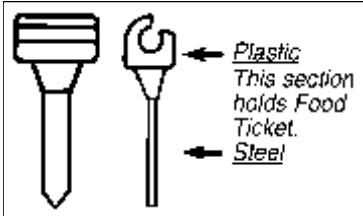

3EHB2MS

Has a regulation spike length of 25mm. The spike is made from stainless steel.

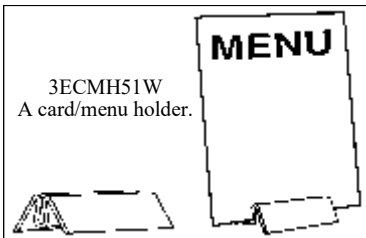

3ECMH51W
A card/menu holder.

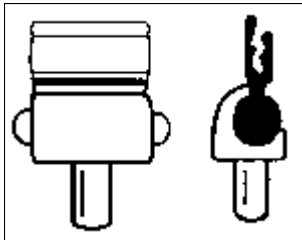

3ETH1HB

Used to hold smaller sized signs & show cards. The HB allows connection to other components.



I57810

3EHC
Clips onto either baskets or cooling wires.



3EPT1010



3EPT2100

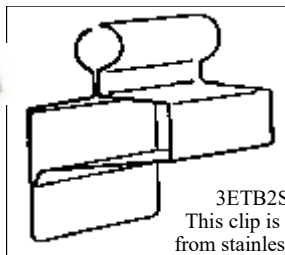

3ETB2SS
This clip is made from stainless steel & is totally heat resistant. To clip on all high temperature trays & dishes.

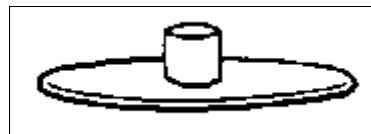

3ERBW
Provides a stable base for tickets on a flat surface.

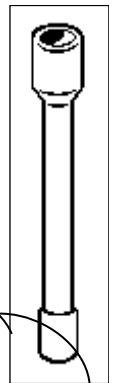

3EERW
Used to raise the ticket height.



I70220



I70221



I70272

3EHBW
Required to connect tickets with other components.

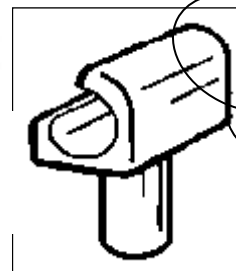

See previous page for examples!

TICKETS & PRICE TAGS

Description	Dimensions	Code
Fixed Base clear Spike - S/S HB white	50mm Pack of 10	3EFB50
Menu/Card Holder - white	Pack of 5	3EHB2MS
Menu/Card Holder - S/S	Pack of 1	3ECMH51W
Ring Menu Card Holder S/S	45mm Pack of 1	I70220
Tray Clips - S/S, heat resistant	55mm	I70221
Round Base - white	Pack of 5	3ETB2SS
Bakery Designer Ticket	Pack of 5	3ERBW
	63mm pack of 5	3ERBB
(Some of the above available in black)		
Pen - Thin (red, black, green, blue)	Pack of 1	3ETNPEN
Display sign - plain	28 x 100mm Pack of 10	1JSIGN
Sign : White - Plain	65 x 165mm Pack of 5	3EDS3P
Labelling System PT-2100, Portable P-Touch 1010 Electronic Labeller	177 x 233x 68mm 190 x 95 x 55mm	3EPT2100 3EPT1010
Use True Type Fonts from your PC. Tapes in variety of colours Available In 9, 12, and 18mm		

SIGNAGE

SIGNS

Description	Dimensions	Code
No Smoking Sign	105x140mm	Pack of 1 3EMS10
Wall Sign No Smoking	80x120mm	L57715
Wash your Hands Sign	65x165mm	Pack of 1 3EMS6
Warning Sign	90x125mm	Pack of 1 3EPT3HR
Today Special Sign (Spike Tag)	75x126mm	Pack of 1 3EPT3S3C
Today Special Sign	90x126mm	Pack of 1 3EPT3-18
No Pets Sign	65x165mm	pack of 1 3EDS3-36
Reserved Sign S/S	43x100mm	I57800
Wall Sign Push S/S	60x110mm	I57770
Wall Sign Pull S/S	60x110mm	I57771
Wall Sign Male Symbol S/S	80x120mm	I57711
Wall Sign Female Symbol S/S	80x120mm	I57711
Wall Sign Staff Only S/S	60x110mm	I57782
Wall Sign Toilet S/S	60x110mm	I57756
Table Number Set: 1-50 BL/W	96x102mm	I70251
Table Number Set: 1-25 BL/W	55x55mm	I70210
Table Number Stand S/S	305mm	I70272
Table Numbers 1-10 S/S A Frame	43x53mm	I57810
Sign Open/Closed	280 x 206mm	Pack of 1 3EMS002
Sale Price	74 x 53 mm	3MR51RPA8



3EMS003



I70210



3EMS002



3EMS002 (Double Sided)



3EPT3HR



3MR51RPA8



3EMS10



3EPT3S3C



3EPT3-18



3EDS3-36

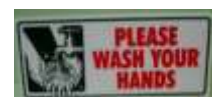

3EMS6

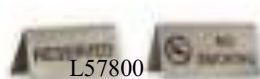

L57800



SIGNAGE



Q04133

SIGNS/NEON		
Description	Dimensions	Code
Sign: Trading Hours	205 x 280mm Pack of 1	3EMS003
Exit Sign	100x292mm	
Sign / Menu Holder (Clear)	120x150mm	Q04133
A4 Sign / Menu Holder (Upright)	218x330mm	3EA4S
Neon Led Sign - OPEN - Horizontal	350 x 580 mm	3ELED1
Neon Led Sign - OPEN - Vertical	680 x280 mm	3ELED3
Neon Led Sign - SALE - Horizontal	350 x 580 mm	3ELED2



3ELED2



3ELED1



3ELED3



OR1028

DATING/PRICING GUN	
Description	Code
JSL. Primark Price Coder	O147053
JSL. Primark Date Coder	O147055
Range of pre printed labels available	OR1028



PROTECTIVE WEAR

SIGNS		
Description	Dimensions	Code
Cut Resistant Glove Handguard glove, single Oven Gloves & Mitts Glove - Oven, single - Elbow, length oven - single - Pair with cuffs - Pair, reinforced - Leather Oven Holder Oven Holder - single, terrycord Heat Glove / Red & Black	400mm 270mm 260 x 310mm 295 x 26mm 28x16cm	1KG-WH 2MSM-026 2MSM-025 Q3159024 2U44391 2UGLOVE 2MSM-027 1KOVENPAD Q67205
Terry cord Glove with fingers Crusader flex Glove	30cm long 36 cm long	1KGLOVE 1KG-42-474
Bakers glove Leather Flame guard Oven Mitts	43 cm long 43 cm long	I60843 1R773012
Disposable Gloves Glove - clear vinyl, medium Glove - thick vinyl, medium Glove - vinyl	10in long 90cm long	1KG-550m 1KG-650 1KG-JK



APRONS		
Description	Dimensions	Code
Bib Style - PVC heavy duty, white PVC, white drill cotton - white navy black with pocket, drill cotton, white	90 x 120 cm 90 x 120 cm 85 x 72 cm “ “ 72 x 86 cm	1KA-P1 1KA-F1 1KA-C5W 1KA-C5NA 1KA-C5BLK 1KA-C4W
Waist, short - white black	71 x 50 cm “	1KA-C10W 1KA-C10BLK
Waist, long - white navy black	85 x 72 cm “ “	1KA-C6W 1KA-C6N 1KA-C6B
Waist, extra long - white	86 x 90 cm	1KA-C8W
Popover navy royal red green white light blue	46 x 80 cm “ “ “ “ “	1KA-P3NA 1KA-P3ROYAL 1KA-P3RED 1KA-P3G 1KA-P3W 1KA-P3LB
Heat Glove	28x16cm	Q67205



Waist Apron



Bib Apron



1KDISPE

GLOVE DISPENSER		
Description	Dimensions	Code
Glove & Tissue Dispenser S/S Easy to fix on the wall	80x137x250mm	1KDISPE



PROTECTIVE WARE

CHEFS UNIFORMS

Description	Dimensions	Code
Chef Jackets with white Buttons / various Sizes		1KC-87100
Chef Jackets with hidden Buttons / available in Different sizes		1KC-5000-8
Chefs Trousers / black & white small check Elastic Polyester/cotton various Sizes		1KC-T410-102
Chefs Trousers / white Elastic Polyester/cotton various Sizes, fob pocket		1KC-2000
Chefs Trousers Black & white small check Polyester/cotton Traditional style, with belt Loops & fly		1KC-T402
Chefs Trousers Black & white small check Polyester/cotton., Baggy style, elastic/drawstring Waist		1KC-T410
Neckerchiefs / Poly cotton / white , Light blue		1KC-NCHIEF-W



1KC-87100



1KC-T410-102

1KC-5000-8



1KC-NCHIEF-



HEADWEAR

Description	Dimensions	Code
Beret drill cotton, white		1KH-3661WH
Cap Peak, poly/cotton		1KH-3661NY
Cap - Peak, nylon, white with hear net		1KH-3671WH
		1KH-3672



1KH-3671WH



1KH-D1W



1KH-3661WH

CLEANING HARDWARE

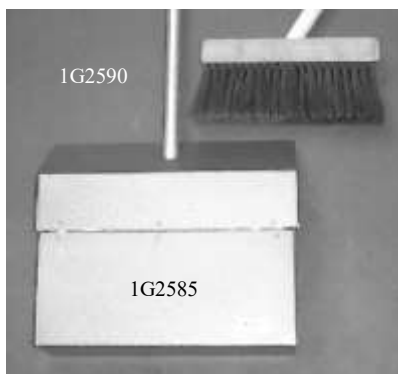

BROOMS		
Description	Dimensions	Code
Broom - Handwhisk	L 300 x W 17mm	1G2021
Broom - Bakers/Millers Pure Hair	30cm	1G2075
“ “	35cm	1G2076
“ “	45cm	1G2077
“ “	60cm	1G2078
Broom - Oven clean wire	30cm	1G2495
Broom “ “ “ & Scraper	20cm	1R118325

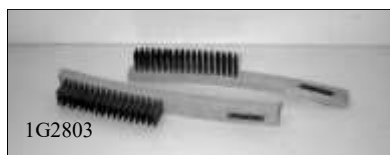

SCRUBBING BRUSHES		
Description	Dimensions	Code
Dairy Scrub		1G2655
Stainless Steel Wire brush 3 Rows		1G2803
Kitchen scrub - Single wing	220mm	1G2638
General purpose scrubbing brush - Nylon	130mm	1G2650
Pot/wok Brush hard Plastic Handle	215mm	I51550



1R118325

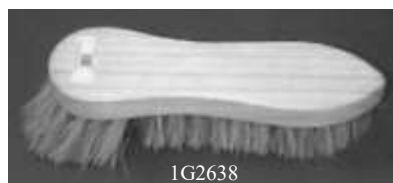

CLEANING HARDWARE

BOARD / FLOUR BRUSHES

Description	Dimensions	Code	
Plastic grip - Natural Black Hair	300mm	2ULP44745	
Wood grip - Hair blend	300mm	1G2899	
Wood grip - Horse hair	300mm	1G2897	
Polyester (meets HACCP criteria)	White	300mm	HFBK52126W
	Blue	300mm	HFBK52126B
	Red	300mm	HFBK52126R
	Yellow	300mm	HFBK52126Y
	Green	300mm	HFBK52126G



2ULP44745



1G2897



1G2899



HFBK52126(W/B/Y/R/G)

SCRUBBERS & SQUEEGEES

Description	Dimensions	Code
Deck Scrub - Nylon Fill	400mm	1G2461
Deck Scrub with Squeegee	300mm	1G2491
Floor Squeegee - Double - Plastic top	560mm	1G2526
Floor Squeegee - Metal top	350mm	1G2515
“ “	450mm	1G2516
“ “	560mm	1G2517



1G2526



1G2517



1G2461



1G2491

FLOOR SCRAPERS

Description	Dimensions	Code
<i>Stainless steel</i>		
Floor Scraper - Complete	200mm	CSCRAPFL
Blade only	200mm	CSCRAPBL
<i>Plastic</i>		
Floor Scraper Blade (handle not incl.)	250 x 185mm	HHCBL7250W
Paddle Scraper Blade (handle not incl.)	112 x 170mm	HHCBL7112W

HHCBL7112W

HHCBL7250W



CSCRAPFL

CLEANING HARDWARE

MOP BUCKETS & MOPS

Description	Dimensions	Code	
Cotton Mop (blue)	400 gram	2MMHDC-01	
Cotton Mop Large	600 gram	1G2429	
Mop Bucket - Galvanised Heavy Duty	12 liter	1G2442	
Mop Bucket - Plastic	Blue	16 liter	1G2445
	Red	16 liter	1G2446
	Yellow	16 liter	1G2447

V SWEEPER

Description	Dimensions	Code
Fast Efficient dust control	1000mm Head (W)	1G2390
Material Tubular Steel		1G2391
Replacement Head Available		



1G2391



1G2390

SINKS - INDUSTRIAL

Description	Dimensions	Code
Hand Basin S/S	500x400x150mm deep	1PHBP01
Brackets to suit		1PHBBP
Compact Hand Basin	400x215x90mm deep	1PHBC
Cleaners Sink S/S	530x470x230mm deep	1PCS
Brackets to suit		1PBRKTLGS
Pressed Bowl S/S	295x225x130mm deep	1PSSPB01
" " "	317x260x150mm deep	1PSSPB02
" " "	375x317x160mm deep	1PSSPB03
" " "	400x325x170mm deep	1PSSPB04
" " "	430x375x185mm deep	1PSSPB05
" " "	500x345x180mm deep	1PSSPB06
Plug and Waste to suit all of above.		1PWASTE
Knee operated hand basin	500x400x230mm deep	1PKNEEHBT
Hand fabricated bowls & ice wells	300x250x 200mm deep	1PHF10
All sizes Available from	to 800x500x300mm deep	1PHF22



Pressed Bowls can be fit into our Stainless Steel benches at time of Manufacture (see Benches)



Compact Hand basin



Cleaner sink



Hand fabricated bowls & ice wells



Hand basin



knee operated hand Basin

CLEANING HARDWARE

SAFETY SIGNS

Description	Dimensions (mm)			Code
Safety Sign Wet Floor, easy to assemble, Easy to transport, Super sturdy "Small"	H 625	W 300	D 280	2MIW-101
Safety Sign Wet Floor, easy to assemble, Easy to transport, Super sturdy "Large"	1.04	400	400	2MCC-122YW



2MIW-101



2MCC-122YW

HOUSEKEEPING - MISCELLANEOUS

<i>CLING WRAP CUTTERS</i>	
Description	Code
33 cm	2DWC



2DWC

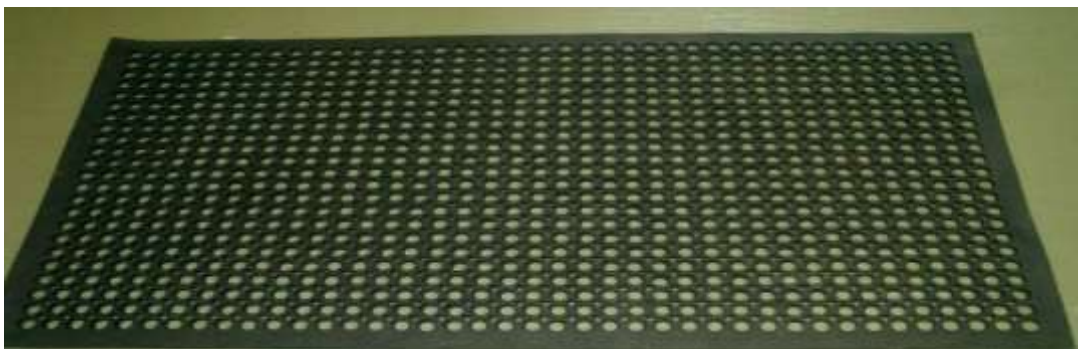

<i>Floor Mats</i>	
Description	Code
RUBBER MAT Black -5x3ft / 152x91cm	I41200-BK

HOUSEKEEPING/MISCELLANEOUS

CAKE DECORATING

Description	Code
Cake Decorating Book	1C17019700
Easy as 123 Decorating Book	1C21040792
Decorating 2002 Year Book	1C17012002



CAKE DECORATING / CANDY MAKING

Description	Code
Candy Making Video	1C09010125
Wedding Cake Video	1C09010128



PAPER ROLL DISPENSER ROLL TOWEL

Description	Dimensions	Code
Paper Roll Dispenser / White	340x205mm	N519022
Premium Roll Towel	190x115mm	N550180



N550180

N519022

ASHTRAYS / SAFETY SPIKES

Description	Dimensions	Code
Stainless Steel Windproof Ashtray	12x7cm	3NSS-M
Stainless Steel Stand Ashtray	61x25cm	I40090
Safety Spikes / Different Colours	180mm	3NSAEE-T
Floor Ashtray S/S 310x190mm		Q40088



3NSAEE-



3NSS-M



Q40088



Q08386



I40090

COUNTER SERVICE BELL

Description	Code
Brass Call Bell	Q08386

SHELVING

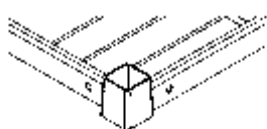
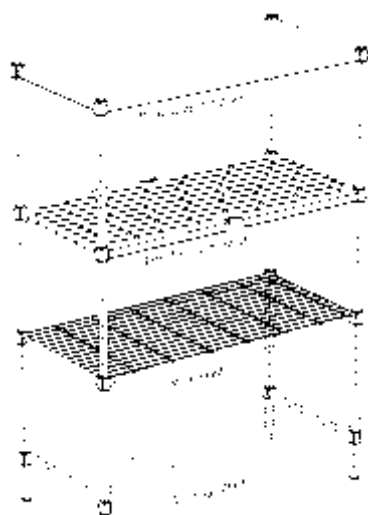

Wedge



Nylon Foot
(Black Foot)



Foot Pad



Bulk Wine Module



Compartmented Wine Module

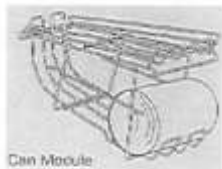

Can Module



Tray Slides

POST SHELVING

Description

Posts

- Galvanised or Stainless Steel
- Manufactured from 1.2mm thick steel
- Dimensions: 25 x 25mm
- Your choice of: - stainless foot - allows floor fixing and provides 65mm adjustment
- nylon foot (provides 32mm of adjustment) + foot pad (distributes load)
- castors - 125mm fit securely to leg

Shelves

Wire Grid

- welded frame
- 4mm wires and 25mm centres on 8mm supports

Real Tuff Moulded ABS - Black

- safe for freezers and dishwasher

Solid Drop on Shelves

- galvanised or stainless

Dunnage Shelves (suitable as bottom shelf)

- 25mm x 25mm x 1.6 tube frame
- for extreme loading - up to 400kg per shelf

Finishes

- Zinc Electroplate and Lacquer
- Hot Dip Galvanised
- Powder Coat
- Polished Stainless Steel
- "As Welded" Stainless

Dimensions

Length:

- Wire Grid, Solid & ABS Shelves 600mm - 1800mm (increments of 150mm)
- Dunnage Shelves 900mm - 1650mm (increments of 150mm)

Depth

- Wire Grid and Solid Shelves: 300, 375, 450, 525, 600mm
- Moulded ABS Shelves: 300, 450, 600mm
- Dunnage Shelves 450, 600mm

Height

- Standard: 1200mm (3 tier), 1800mm (4 tier), 2000mm (5 tier)

Extra tiers can be added at your cost.

SHELVING ACCESSORIES

Description

Code

Wine Modules

Bulk or individual compartment style
Suitable for 300mm or 450mm shelf units

No.10 Can Module

Accommodates 6 cans
Fits any 400mm frame, but is best suited to 900mm size which fits 4 modules per tier

KN010

Tray Slides

Suitable for wire grid shelves only
capacity for 11 trays

K11TS

SHELVING

SHELVING ACCESSORIES

Description	Code
Back/ Side Ledges <ul style="list-style-type: none"> • Suitable for wire grid shelves only (lengths available to fit all shelf sizes) • Ledges attach to shelf using clips supplied with the ledge 	
Product Stop <ul style="list-style-type: none"> • Suitable for moulded or dunnage shelves (lengths available to fit all shelf sizes) • Each end secures to posts above the shelf • Available as three sided units where both rear and side ledges are required 	
Shelf Divider <ul style="list-style-type: none"> • Suitable for wire grid shelves only (lengths available to fit all shelf sizes) • Standard height 250mm. • Heights of 200, 150, or 100mm can be made to order • Divider clips into front and rear shelf frame 	
Drop in Shelves <ul style="list-style-type: none"> • Solid trays which fit into shelf frame • Standard tray depth of 35mm (possibility of having other depths made to order) 	
Adjustable Feet	
Post Clamp <ul style="list-style-type: none"> • Use to lock adjoining shelf units into line and secure tall narrow units. 	K0330
Post Joiner <ul style="list-style-type: none"> • Allows extension of post heights on existing shelf units 	K1500
End Caps <ul style="list-style-type: none"> • Use to seal off open end of each post. 	
Floor Track	
Security Shelving	

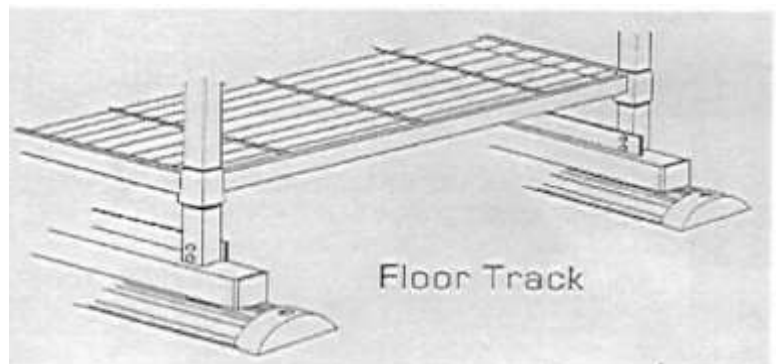
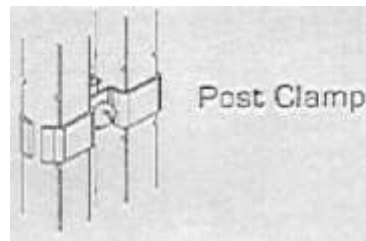
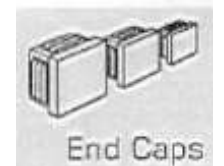
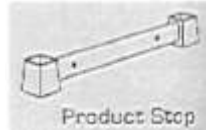
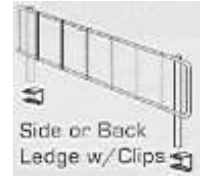

FURNITURE



Coburg



Candy



Clement



La Vaunte



Boulevard



Weave chair



Aluminium Slat



SGM-1



Heywood



Bella chair



Arcadia Chair



Brumby Stool



Bourke
Stainless Steel



Round top Stool



Coffee cup
Chair



Bella



Banquet



Boulevard



Coburg Stool-
Beech



Colour Sample
Brumby Chair



Brumby



Coburg Bar
Stool- Beech



Le Vaunte Stool



Weave stool



FURNITURE



Jupiter



Beech



travertine



Marble

Also In White & Walnut



Twin Pedestal Table Base



Gull 4



Polina Square Base



Polina round Base



Bar Table With shelf
60cm Round S/S Top



Blitz



Astro



Arrow

Stainless Steel-Top table-complete

Sizes available: In S/S

60

70.....120x60

80.....120x80



Stainless Steel-round Top table Size 60



Stainless Steel-square Top table Size 70



Stainless Steel-Rectangle Top table Size 120 x 60cm

MISCELLANEOUS

INSERT ZAPPER

Description	Approx Coverage (sqm)	Dimensions			Code
		H	W	D	
Tube (fluorescent)					
1 round	80	365	465	130	IIOCC20
2 round	180	365	620	130	IIOCC40
3 round	180	365	465	130	IIOCC44
1 round	180	530	620	130	IIOCC40
2 round	270	530	620	130	IIOCC60
1 bar	60	365	465	130	IIOC15
1 bar	80	365	620	130	IIOC20
2 bar	120	365	465	130	IIOC30
2 bar	180	365	620	130	IIOC40
3 bar	360	530	620	130	IIOC80
Main Sticky Pad					IIZSPM



INSERT ZAPPER—Spare Parts

Description	Code
15 watt Fluor Tube	IIMI15
20 Watt Fluor Tube	IIMI20
Tray Sticky Pad	IIZSPT

STIP DOORS

Description	Dimensions	Code
Strip Doors "See- Thru" Available in clear or Colourful PVC strips Made to order	1.5x75mm wide	



S/S CLERMER

Description	Dimensions	Code
Cleans & Protects S/S wipes with Gentle Lemon Scent, non-toxic & totally organic - Bench tops, Railings - Ovens, Microwaves - Range Hoods, Lifts - Rubbish bins, Tap ware	200x130mm	GSSWIPE



BENCH TOP WRAPPER / ROLLER

Description	Dimensions	Code
Venus 450 Clingfilm Dispenser Firmly Wrapped & Cut by the hot bar which is concealed by a safety guard	600 x 480mm	3VMP7453
Food Wrap Film PVC	445mmx1300m	3VVC745344



Thermo Sealer

450 Cling Film Dispenser

MISCELLANEOUS

HEAT SEALER

Description	Dimensions	Code
Heat Sealer Available in various Sizes	200mm 300mm 400mm	1S11113 1S11115 1S11116
Service Kit available	200mm 300mm	1S11621 1S11622



1S11113

TAPE BAG SEALER

Description	Code
Tape machine Coloured Bagging Tapes	1S10746



CLIP BAG SEALER

Description	Dimensions	Code
Model 1003A, Bag closing machine Closures are available in wide variety of lock opening & colours.		
Model 086 bag Closing Machine with date Coder & Clip Separator		
Available in Semi automatic & Automatic Safe & easy to use, Dating options		
Wire Twist Ties	75mm	84WTT75WT

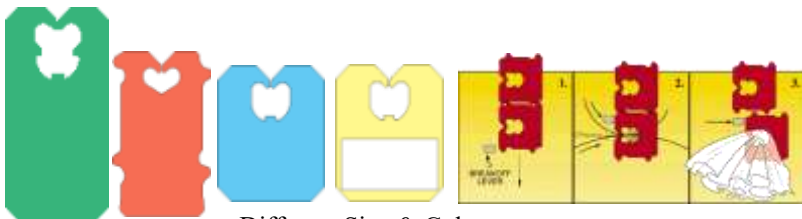

Different Size & Colour



84WTT75WT



SHOPPING BASKET / HOLDER

Description	Dimensions	Code
Shopping Basket Varied colours Available	330 x 460 x 260 mm	3EBasket
Basket Holder Chrome on Castor		3EBHolder



3EBHolder

CASH REGISTERS

ELITE CASH REGISTER - PROGRAMMABLE

Elite CR-202

Budget-priced but big on performance the Elite CR-202 cash register offers many features of much larger and more expensive machines. Suitable for any retail business.

Eight Department

The Elite CR-202 features 8 departments. Departments may be programmed 'Single Item' department for fast registration of single item sales. They can also be programmed with a preset price.

Financial Reports

The Elite CR-202 gives you a thorough review of your business with a complete analysis of your department sales, function totals and actual drawer totals to help you protect your valuable profits. Cash in drawer total via front display.

Optional Receipt/Journal

Single Station Printer can be programmed for either customer receipt or retain transaction record on audit roll. Receipt only on demand facility saves paper. Re-print receipt going back 3 transactions.

- Single Station Thermal Printer.
- Drop & Print Paper Loading.
- 2 Line Alpha Numeric Operator Display.
- Pop-Up Customer Display.
- Heavy Duty Cash Drawer 8 coin, 4 notes.
- Receipt Only on Demand Facility.
- Euro Currency Conversion.
- 8 Departments, 1200 PLU.
- Electronic Journal Facility.
- Training Mode.
- Automatic VAT Calculation.
- Clerk Sign On Facility for 15 Operators.
- Programmable Header & Footer Receipt.
- Cash in Drawer Total by Display.

Dimension: 405 x 425 mm x 230mm H

Code: 1XEL202



CASH REGISTERS

ELITE CASH REGISTER - LARGE INK

Elite CR-101

Budget-priced but big on performance the Elite CR-101 cash register offers many features of much larger and more expensive machines for any small retail business.

Four Department

The Elite CR-101 features 4 departments. Departments may be programmed 'Single Item' department for fast registration. Small footprint at 330(W) x 360(D)mm. The CR-101 cash drawer has 4 coin and 3 note compartments, ideal where space is limited.

Financial Reports

The Elite CR-101 gives you a thorough review of your business with a complete analysis of your department sales, function totals and actual drawer totals to help you protect your valuable profits.

Optional Receipt/Journal

Operator can choose either to have a printed custom receipt or a journal tape. Receipt only on demand saves paper.

- Single Station Printer.
- Receipt or Journal Printer.
- 4 Departments.
- Calculator Function.
- Euro Conversion.
- Automatic VAT Calculation.
- Receipt After Sales Feature.
- Simple To Use.
- Clock with Auto Date Change.
- Secure Mode Lock.
- Easy to Read Reports.
- Economical Paper Use.
- Easy to Read Display.
- Small Footprint.

Dimension: 405 x 425 mm x 220mm H

Code: 1XEL101



1XEL101